

atlantis

serie
78S - 78STT



TO.MA. S.p.a.
ESTRUSIONE ALLUMINIO

FINESTRA A 2 ANTE
- anta con fermavetro -



scala 1:1

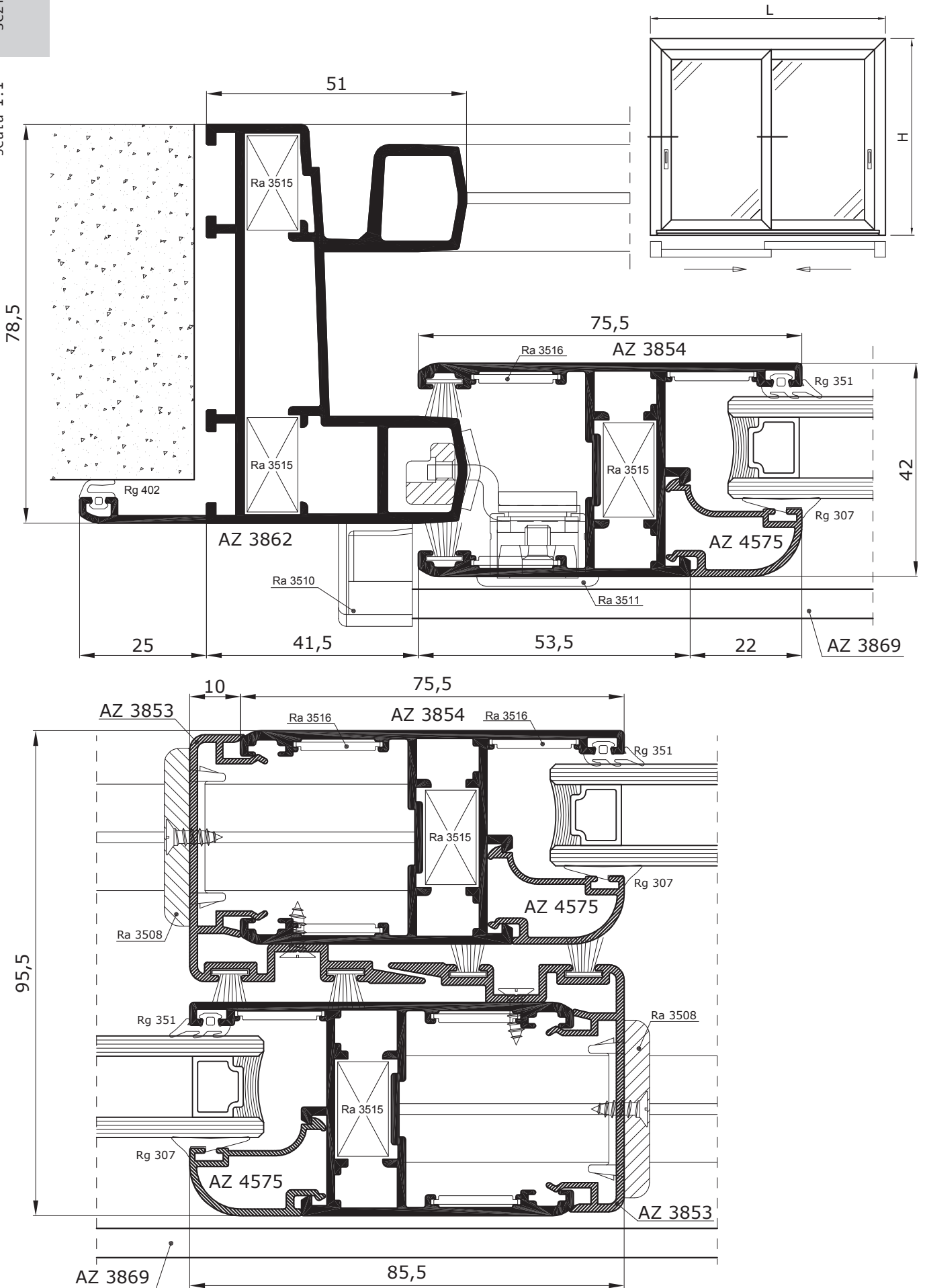

FINESTRA A 2 ANTE
- anta con fermavetro -

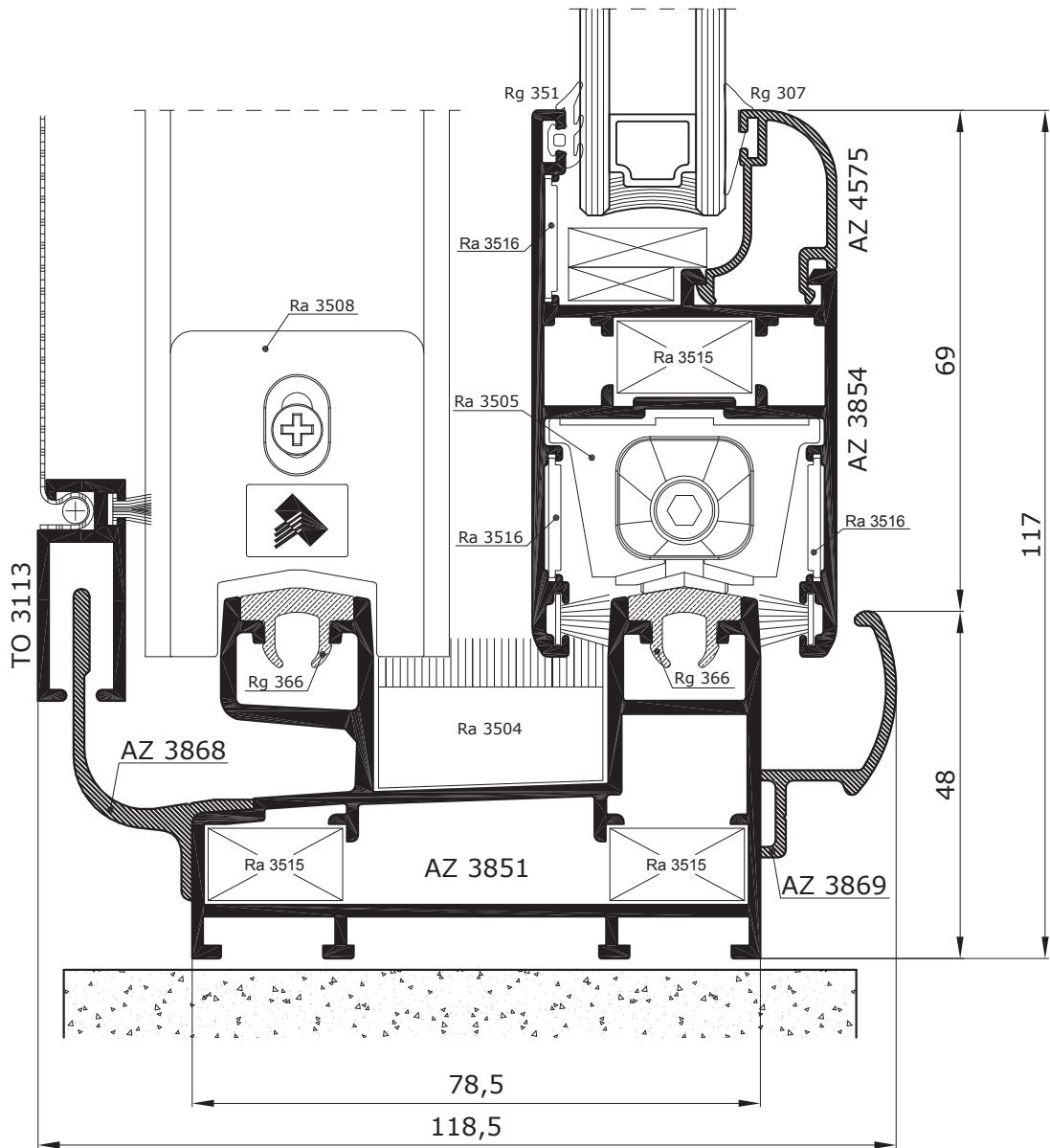
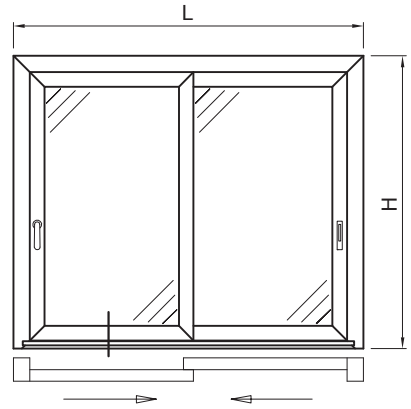

FINESTRA A 2 ANTE
- anta con fermavetro -

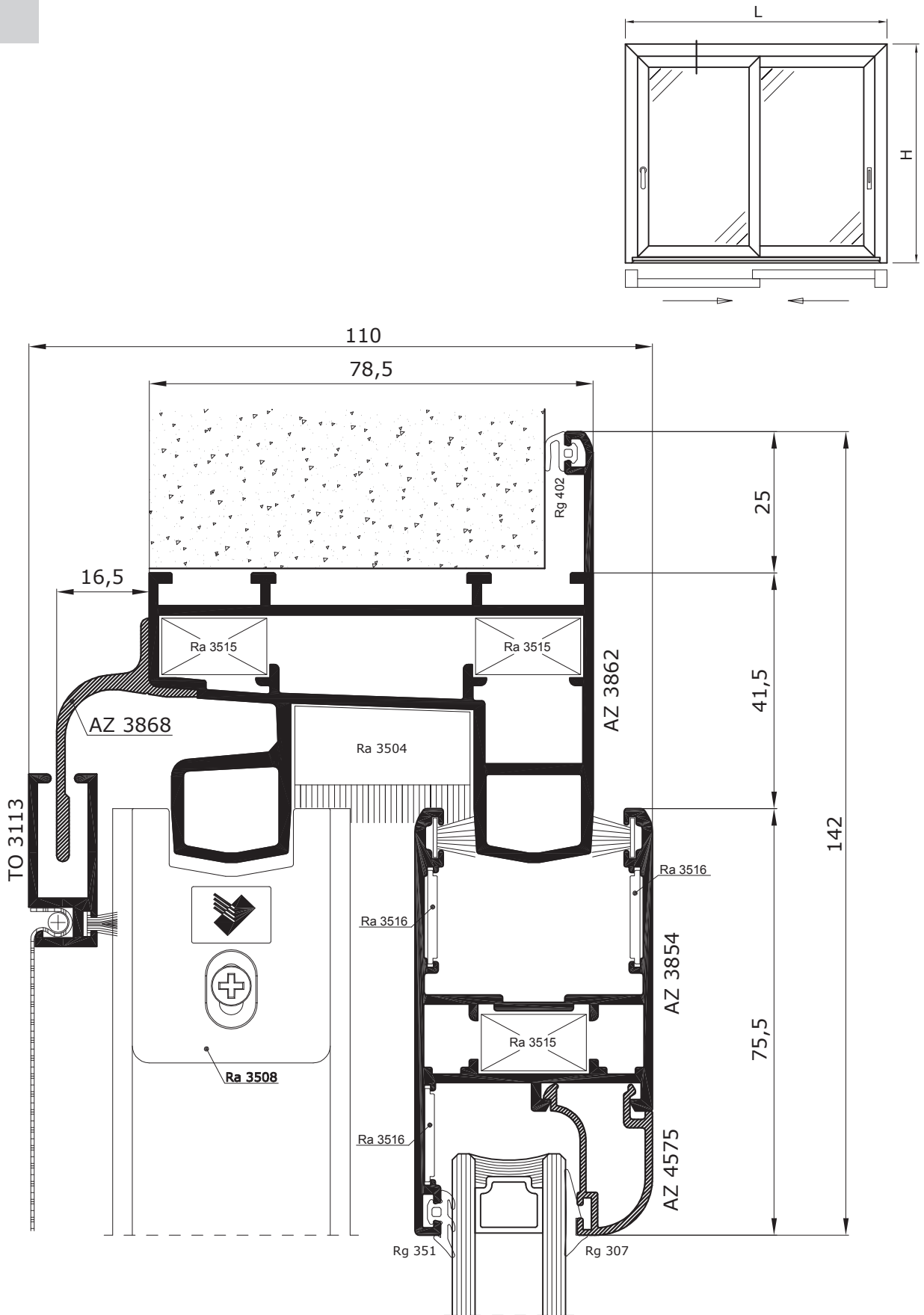



scala 1:1

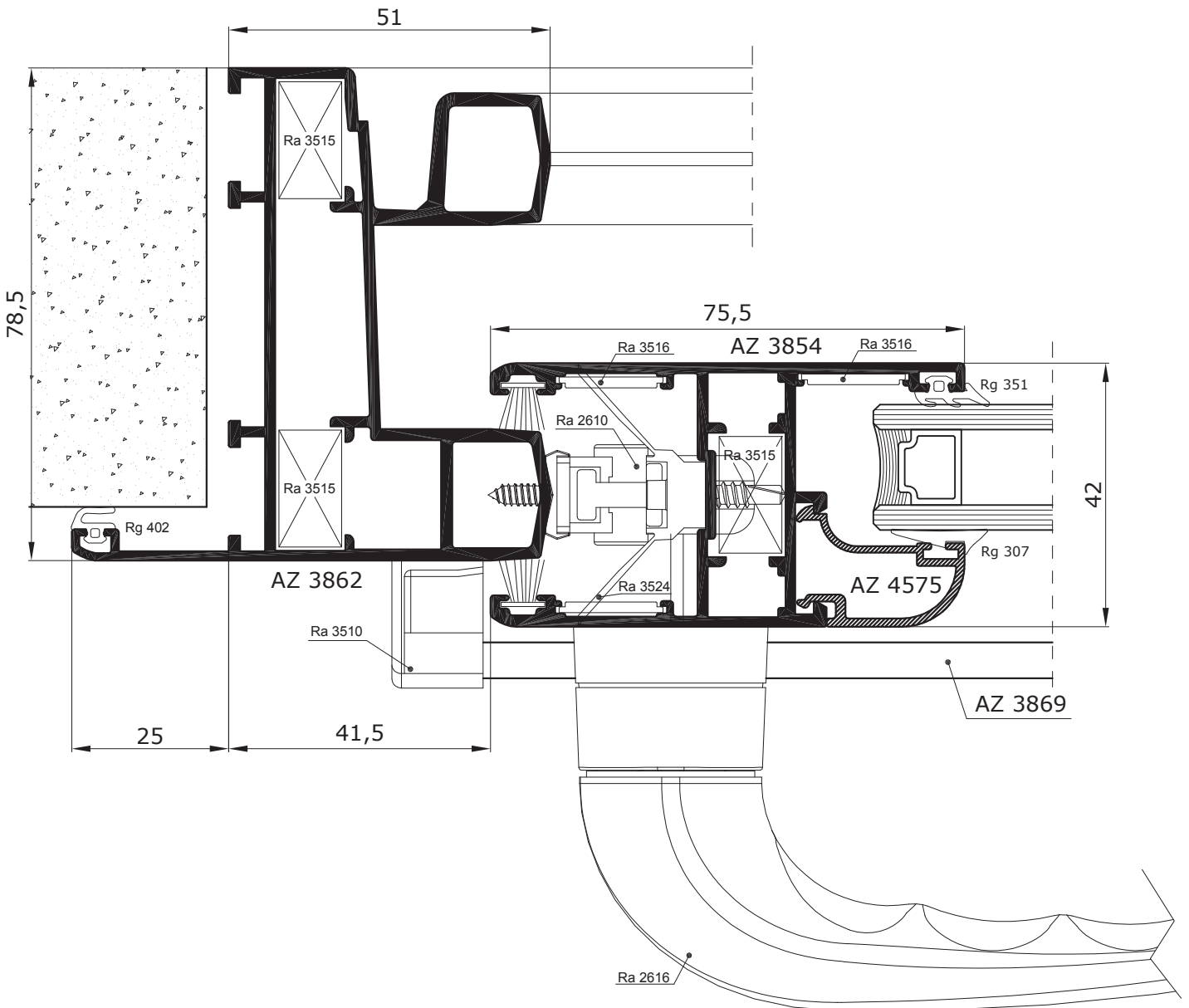
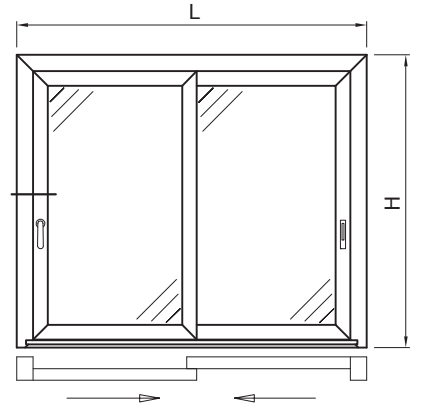

FINESTRA A 2 ANTE
- anta vetro ad infilare e telaio da 98 mm -

scala 1:1

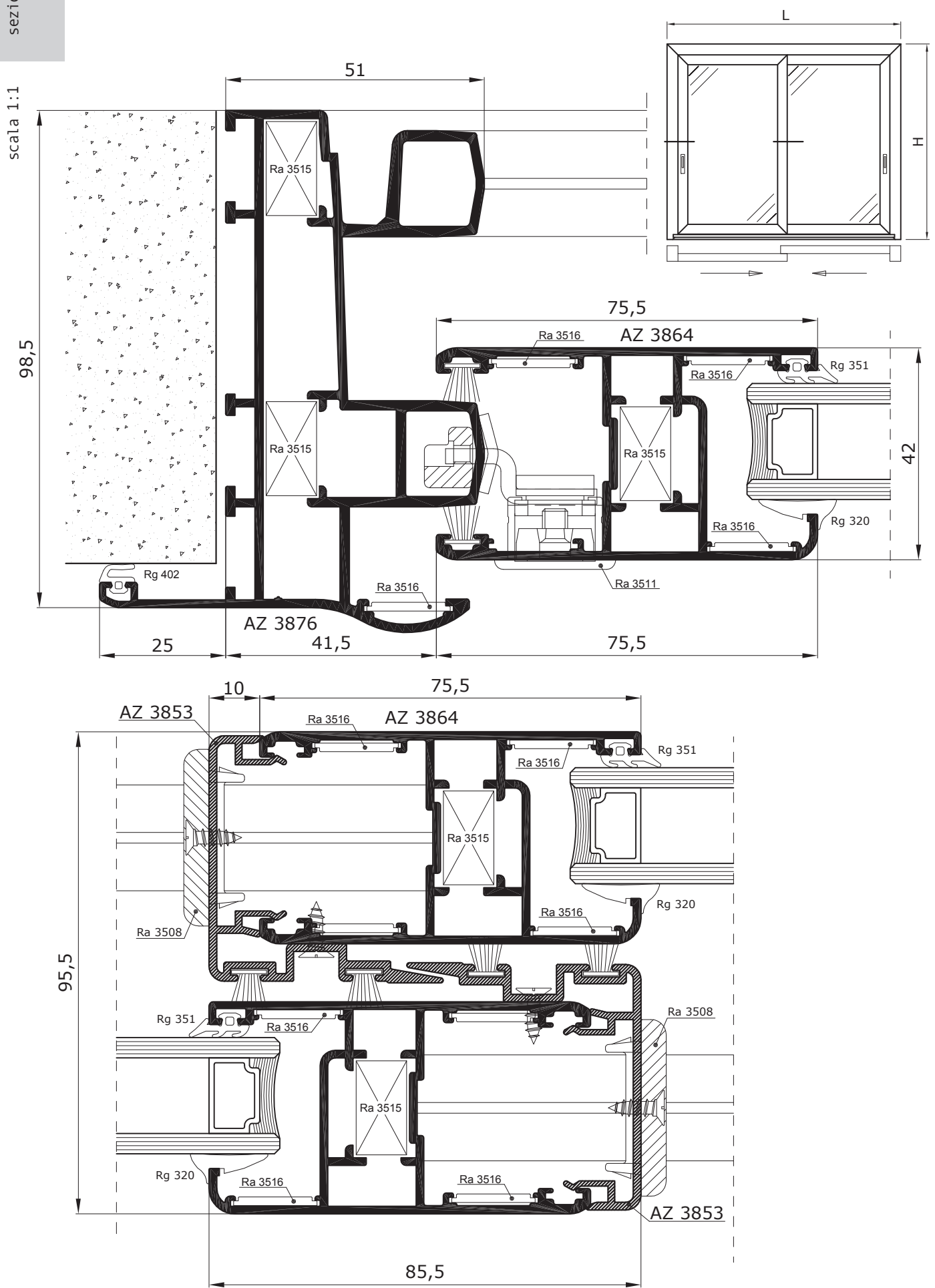

FINESTRA A 2 ANTE
- anta vetro ad infilare e telaio da 98 mm -



scala 1:1

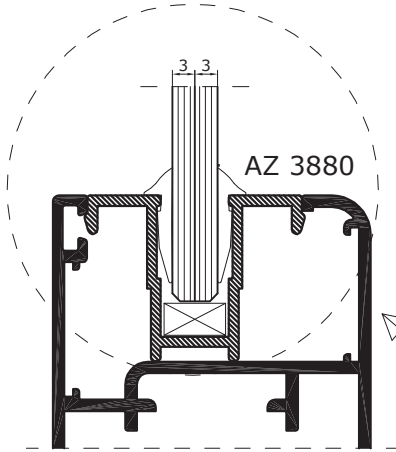

Soluzione vetro singolo

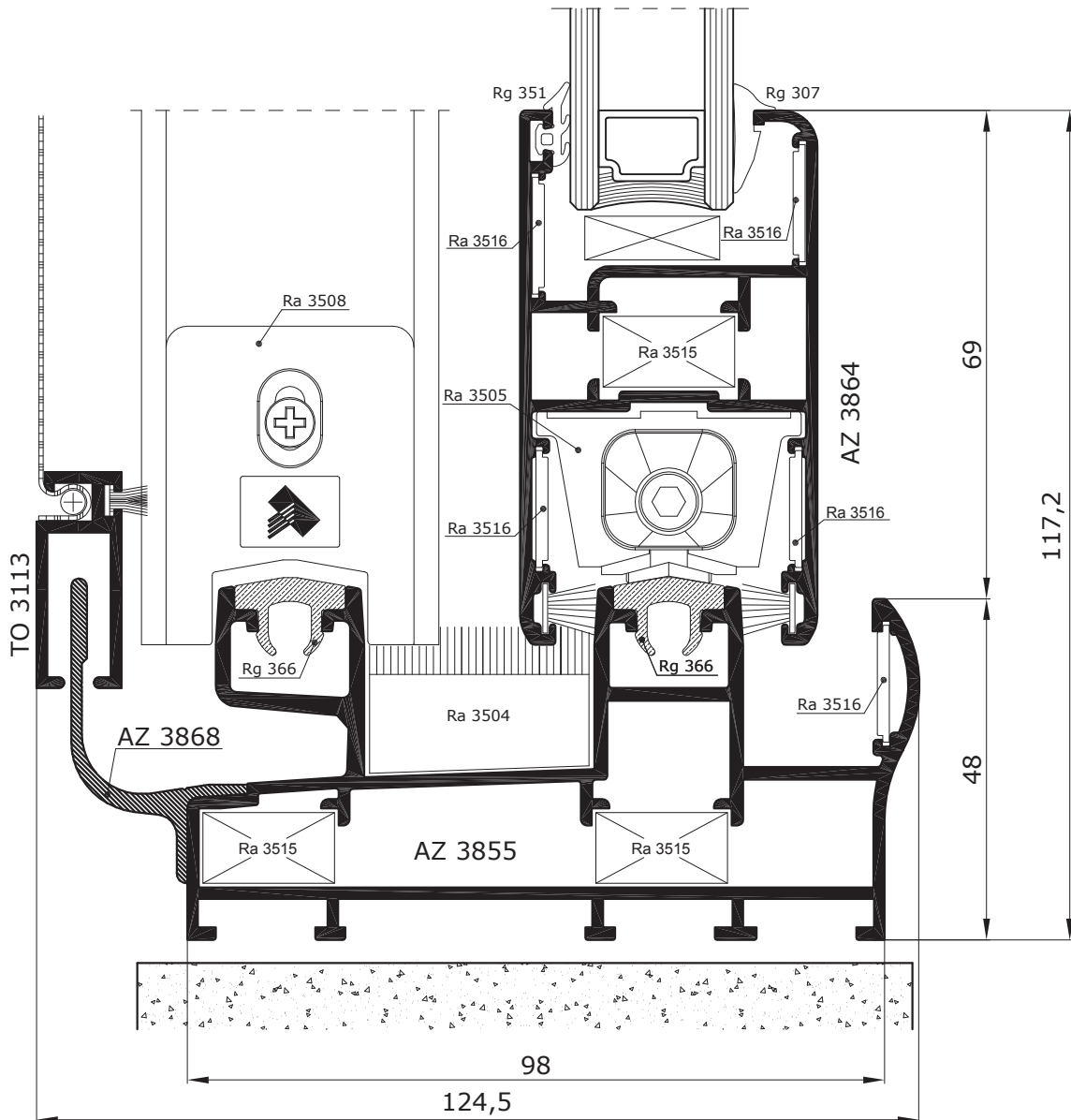
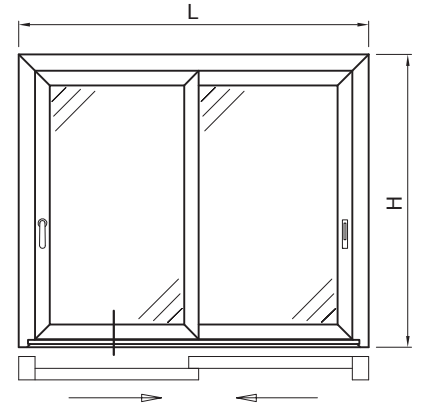



scala 1:1

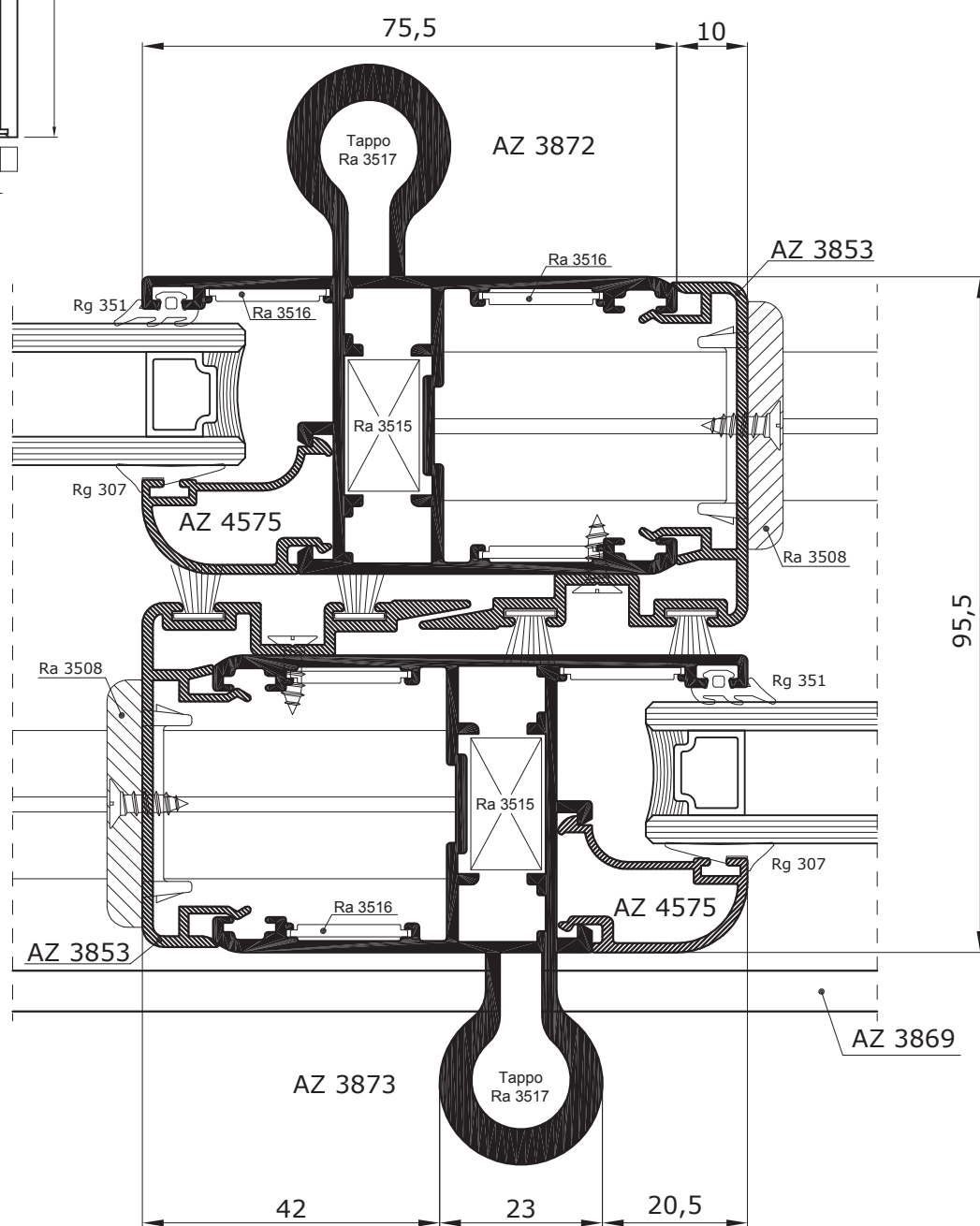
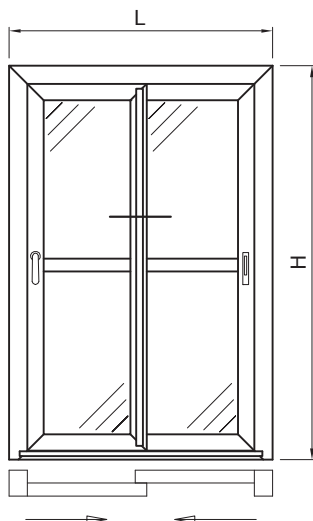

scala 1:1

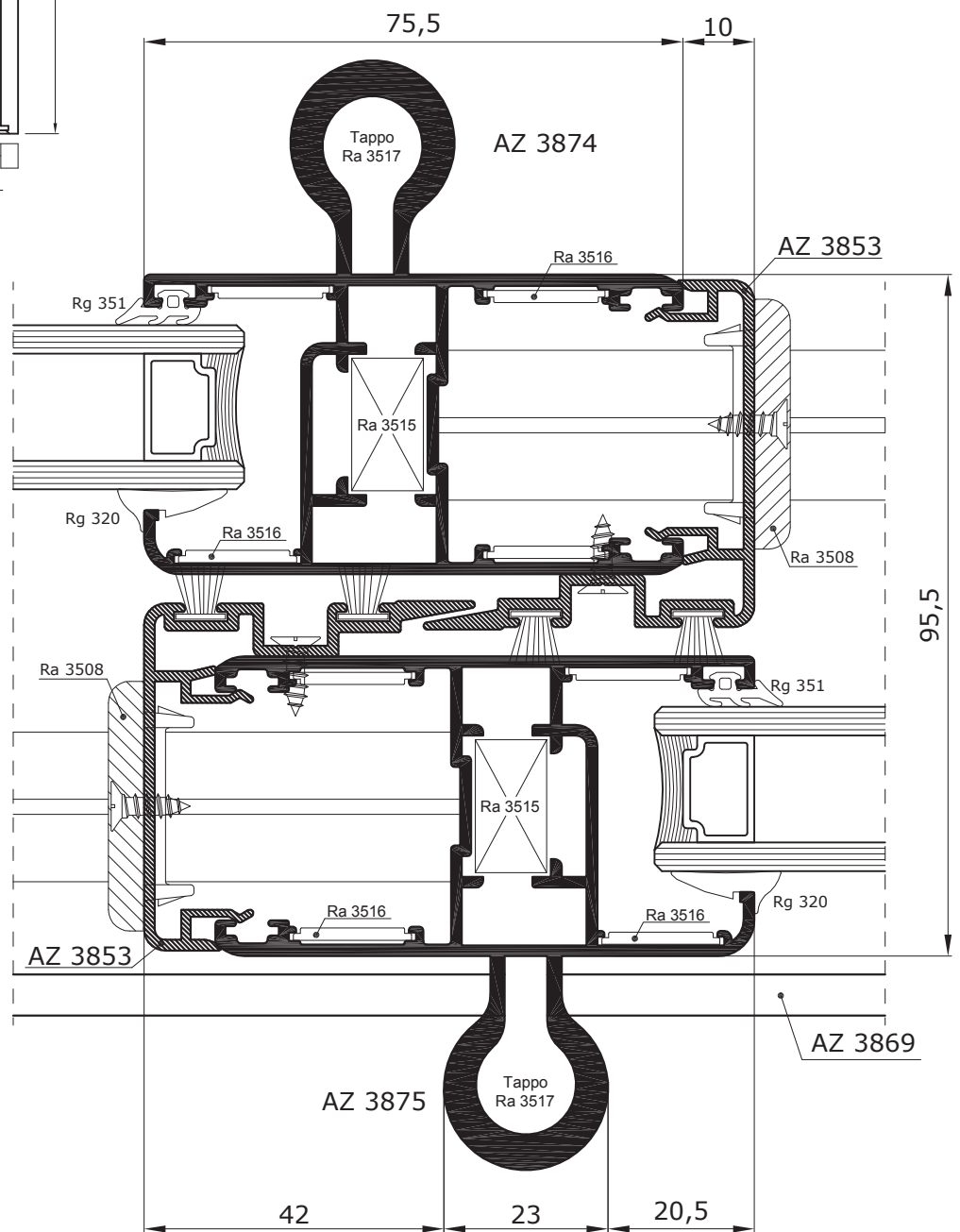
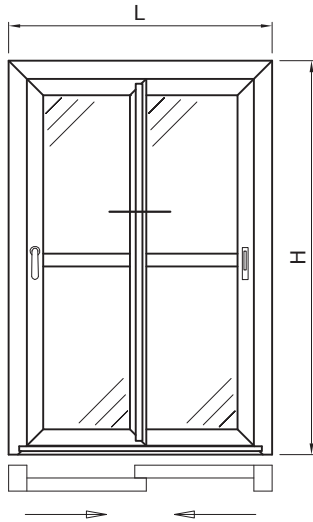



scala 1:1

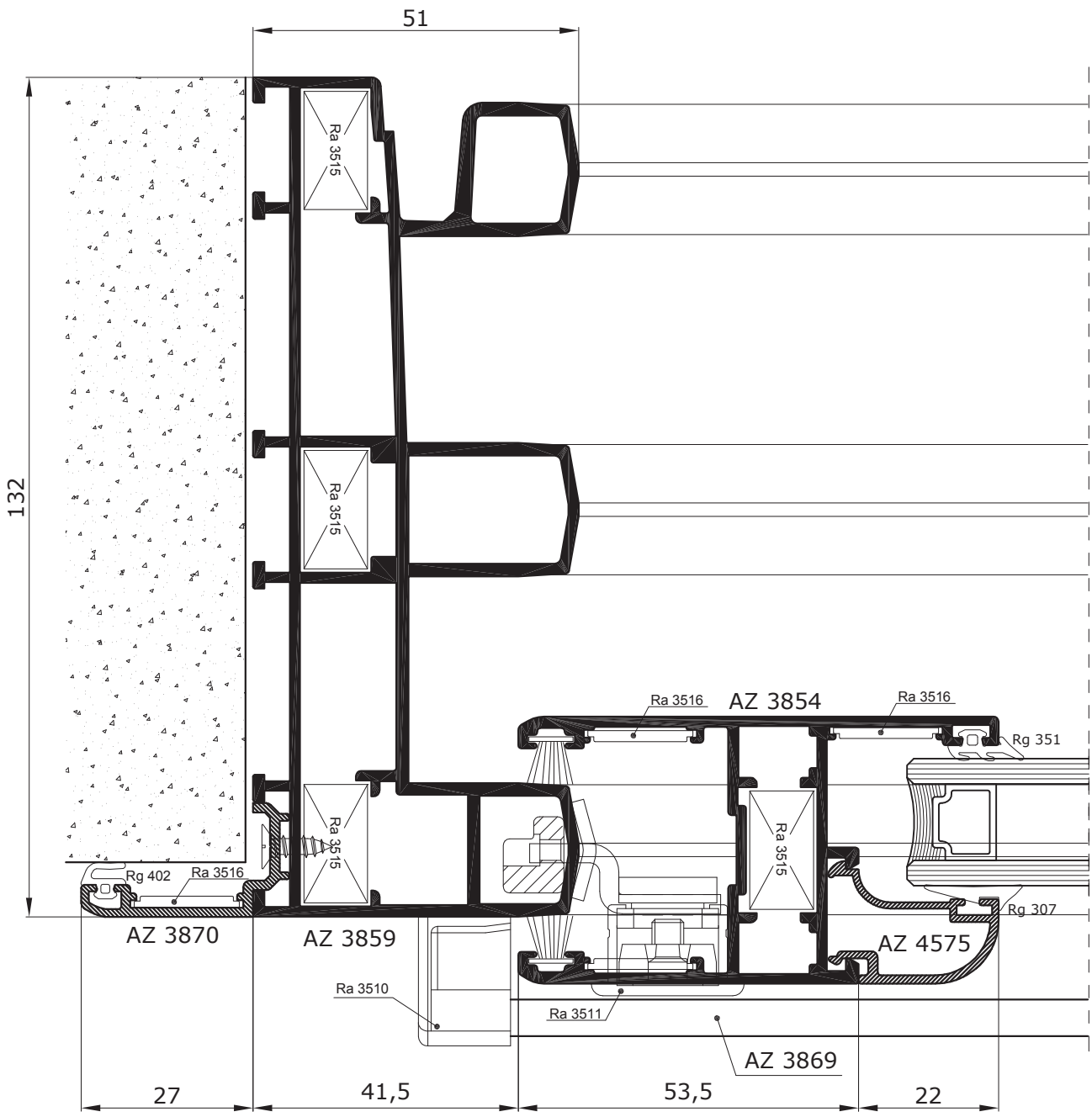
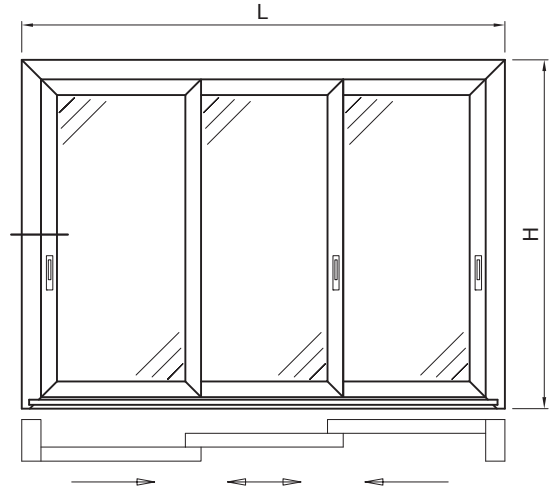



scala 1:1

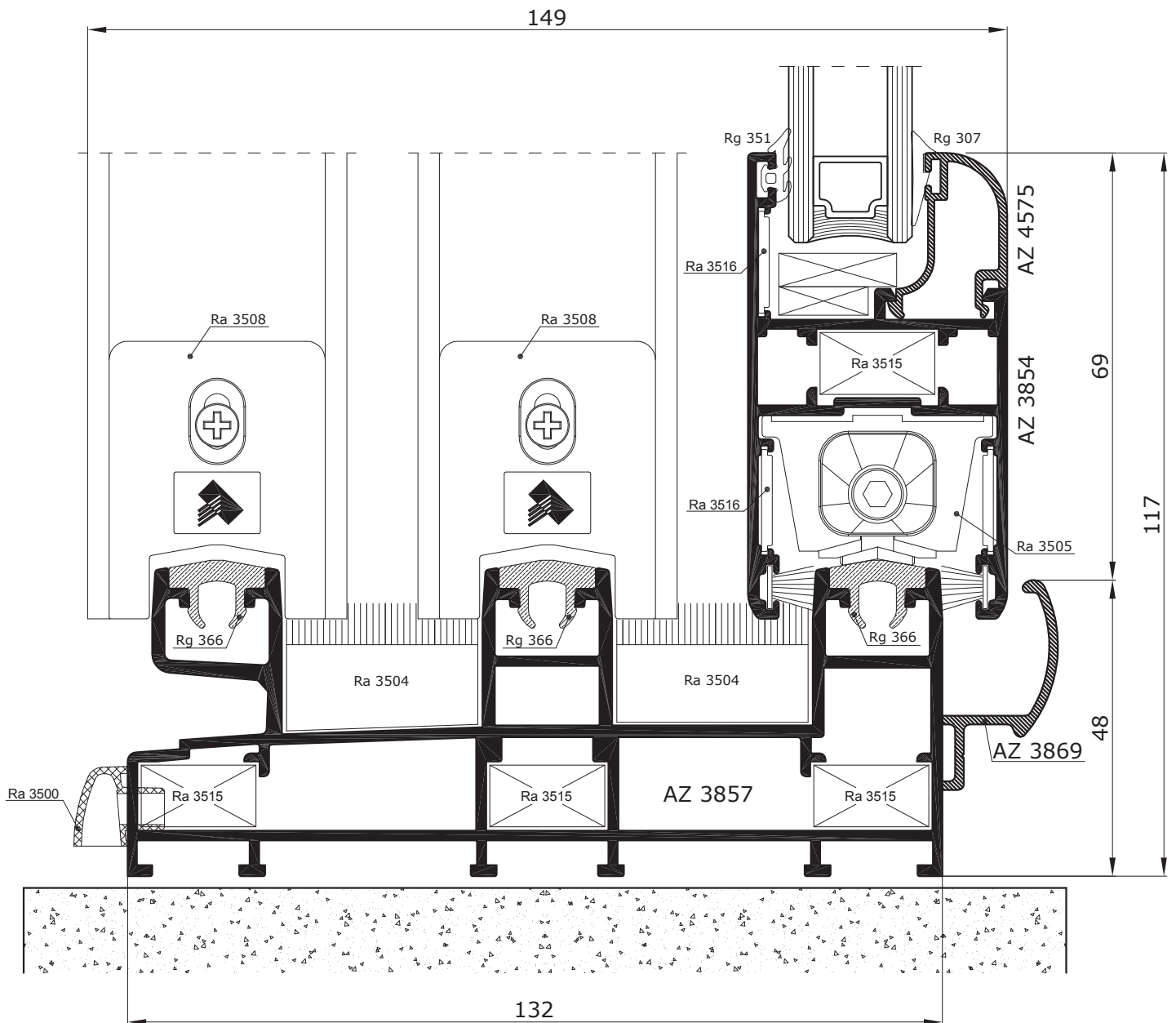
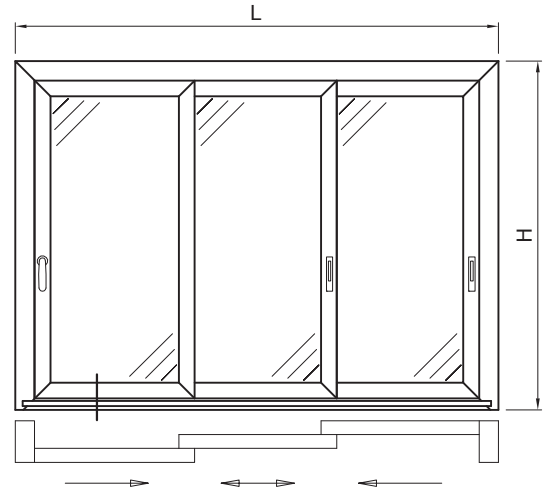



scala 1:1

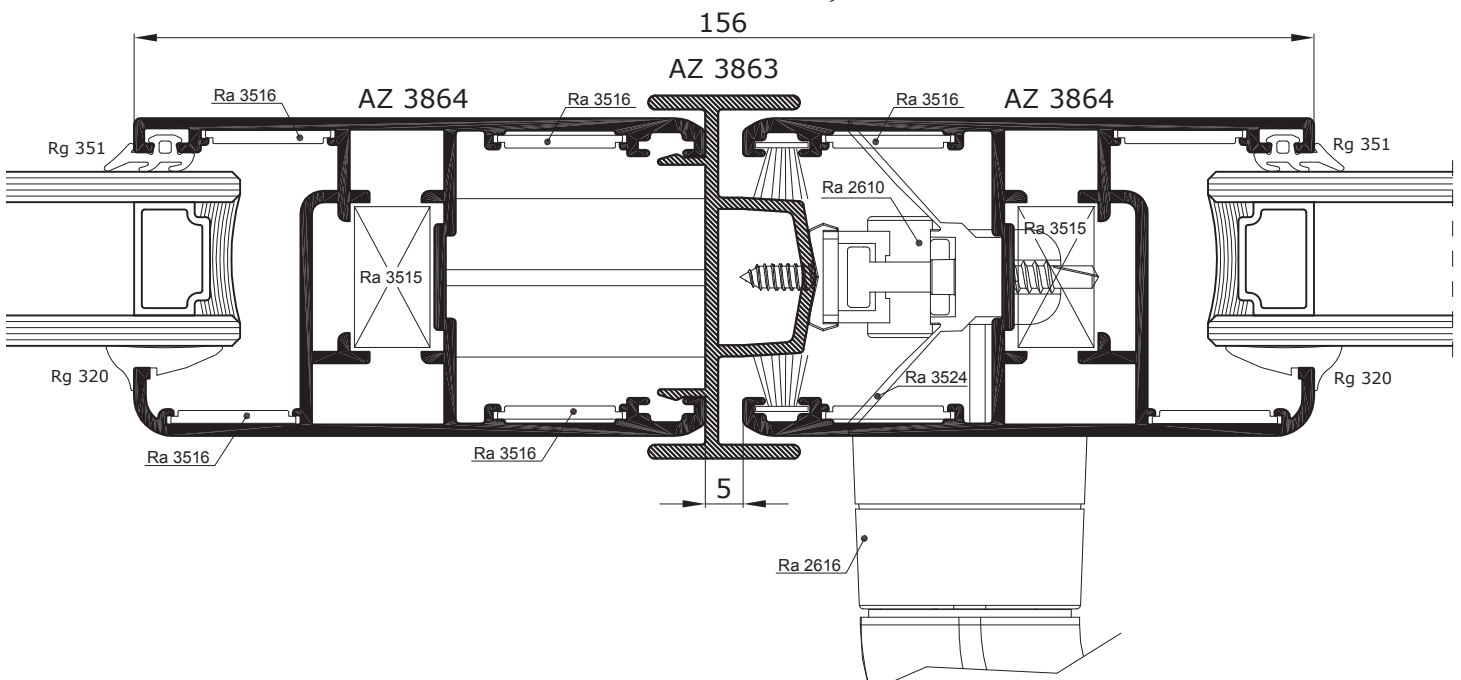
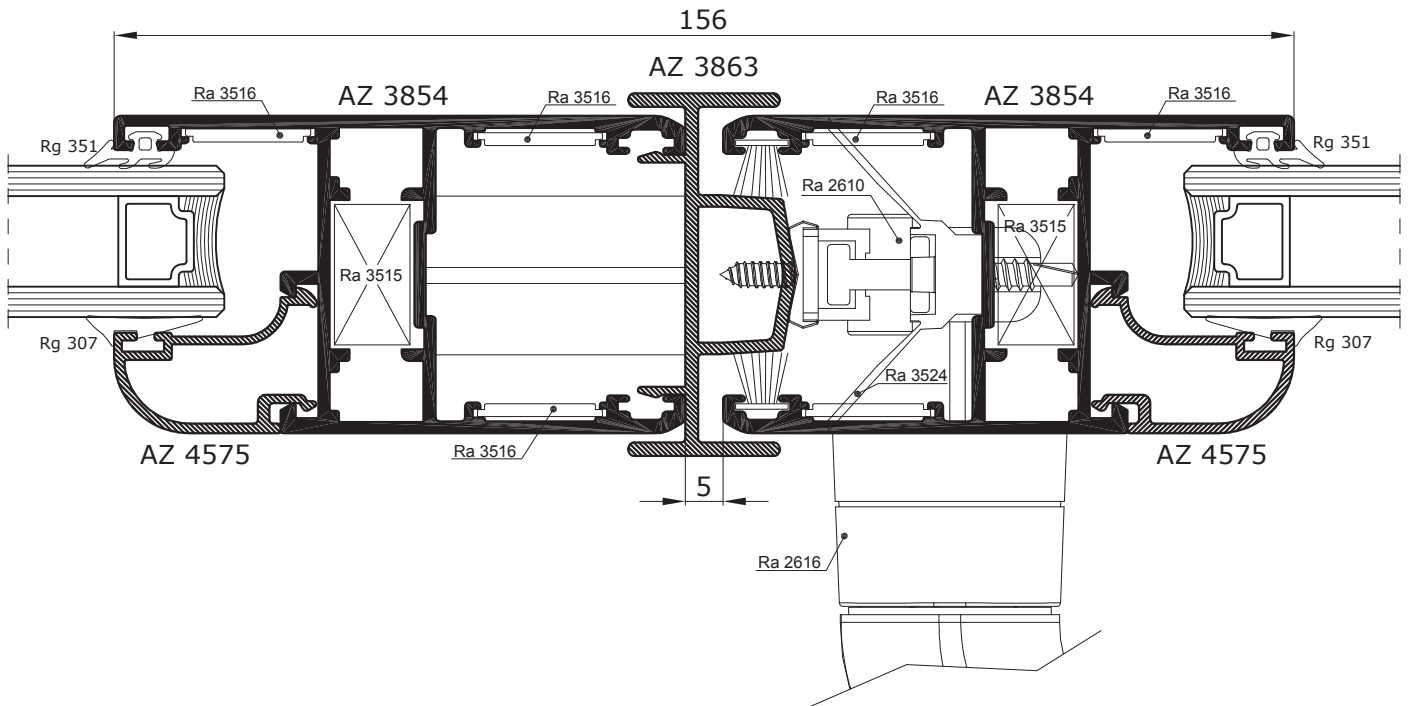
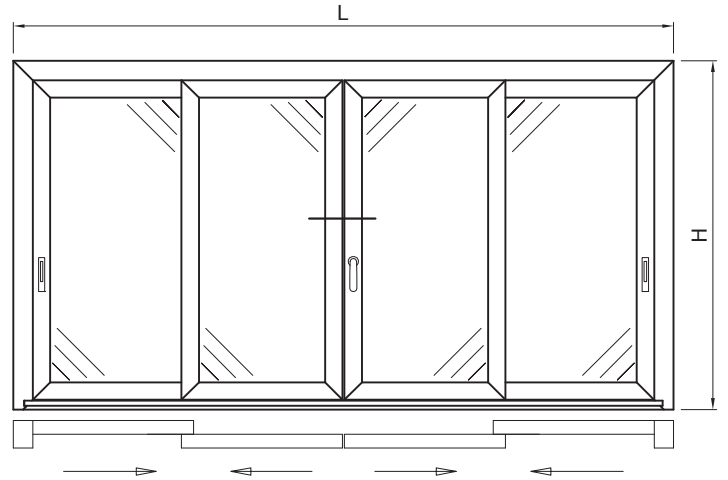

FINESTRA A 3 ANTE
- telaio a 2 vie -

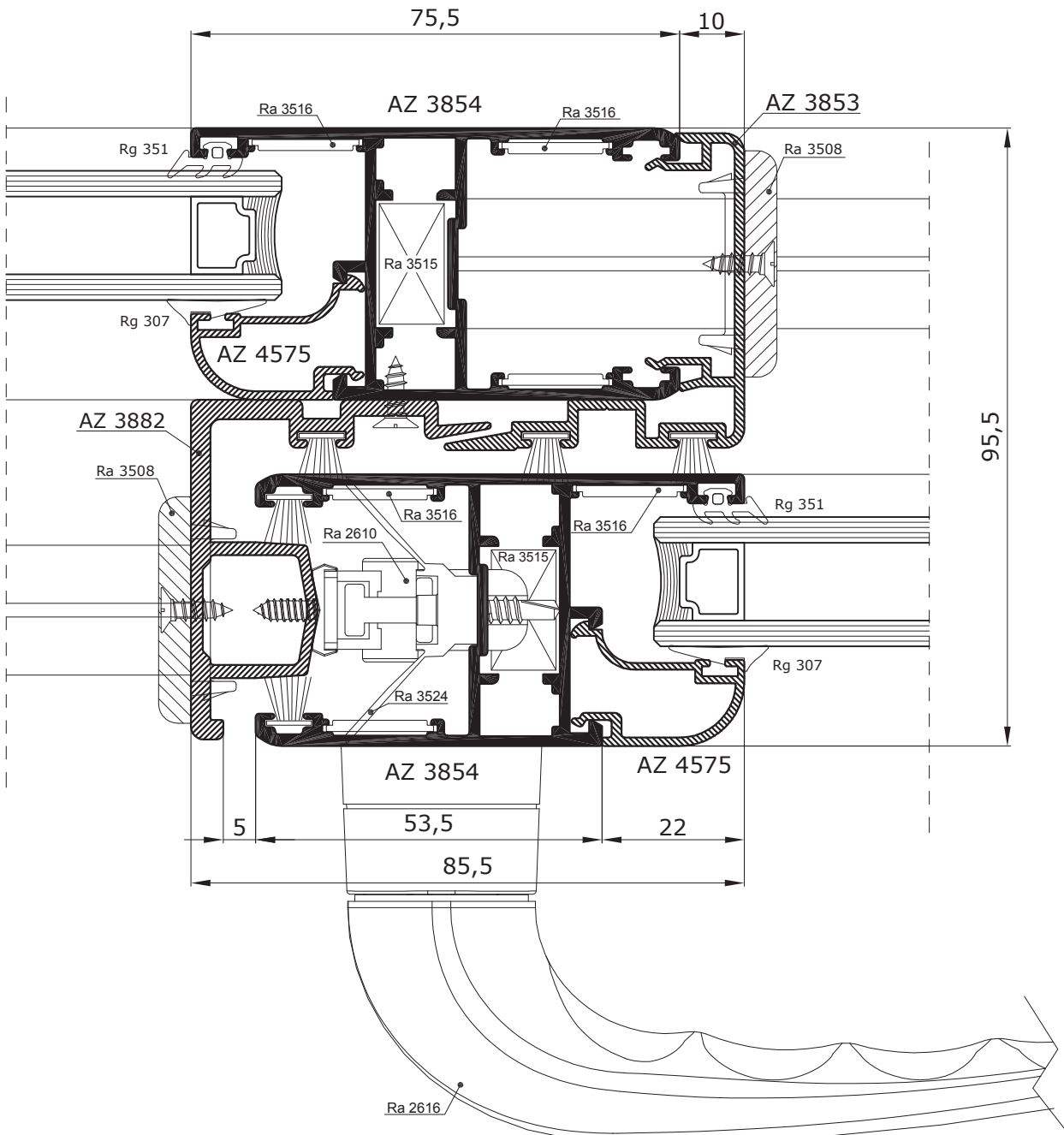
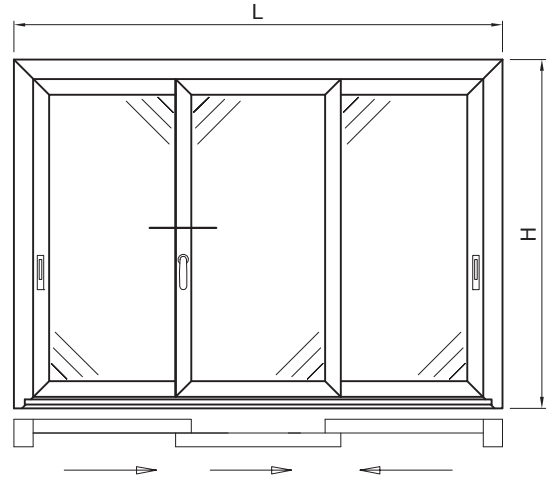

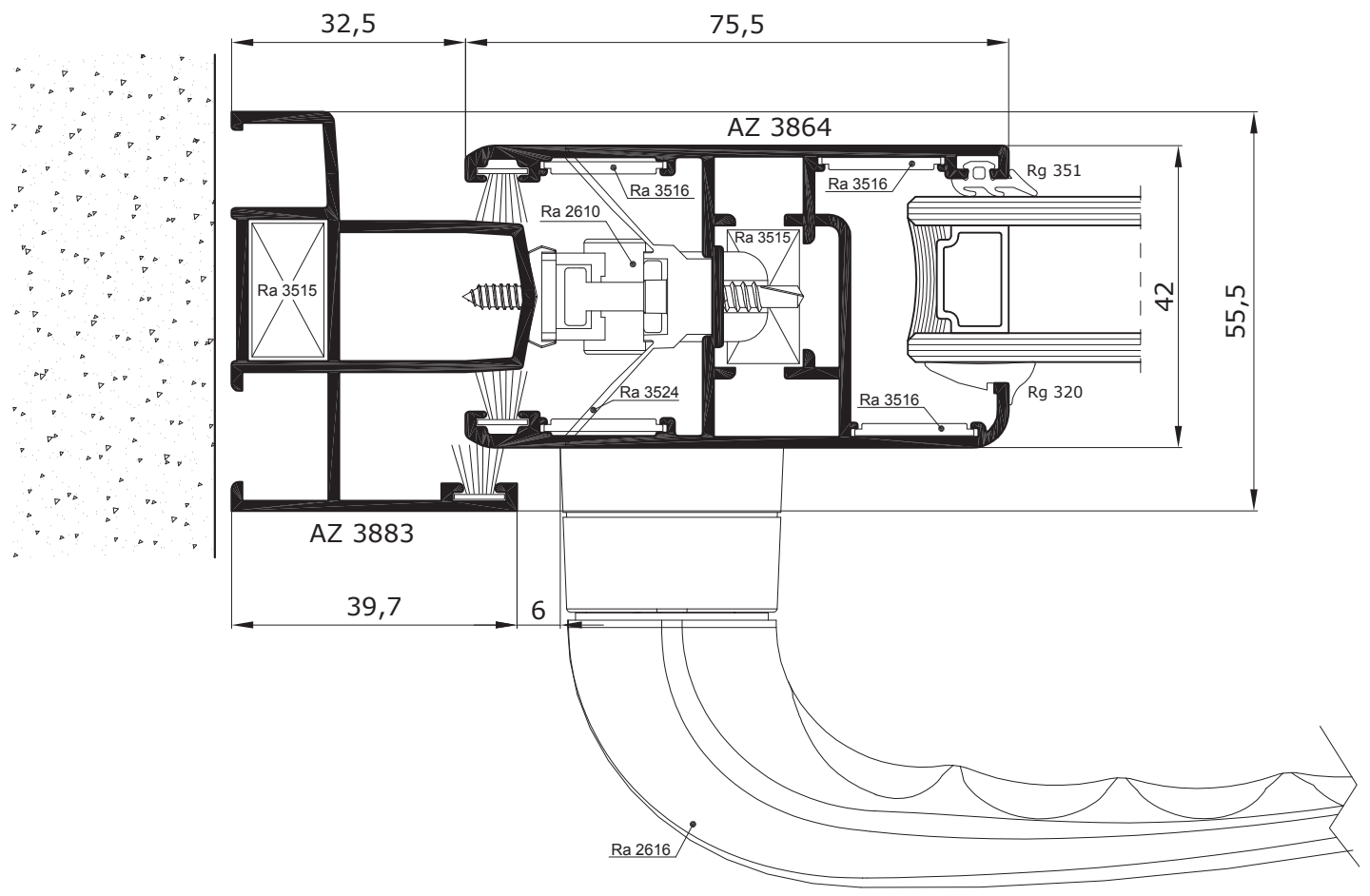
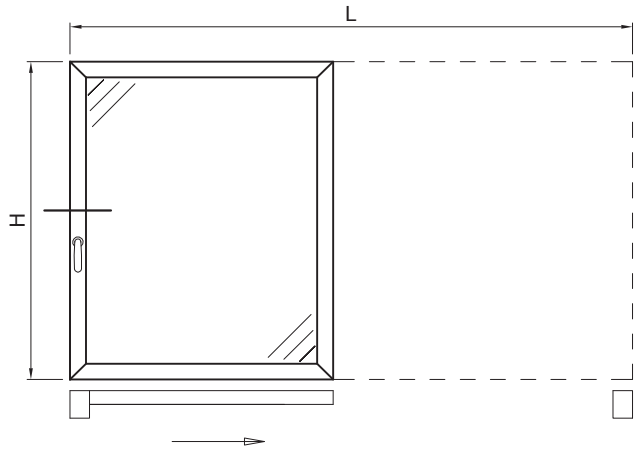



scala 1:1

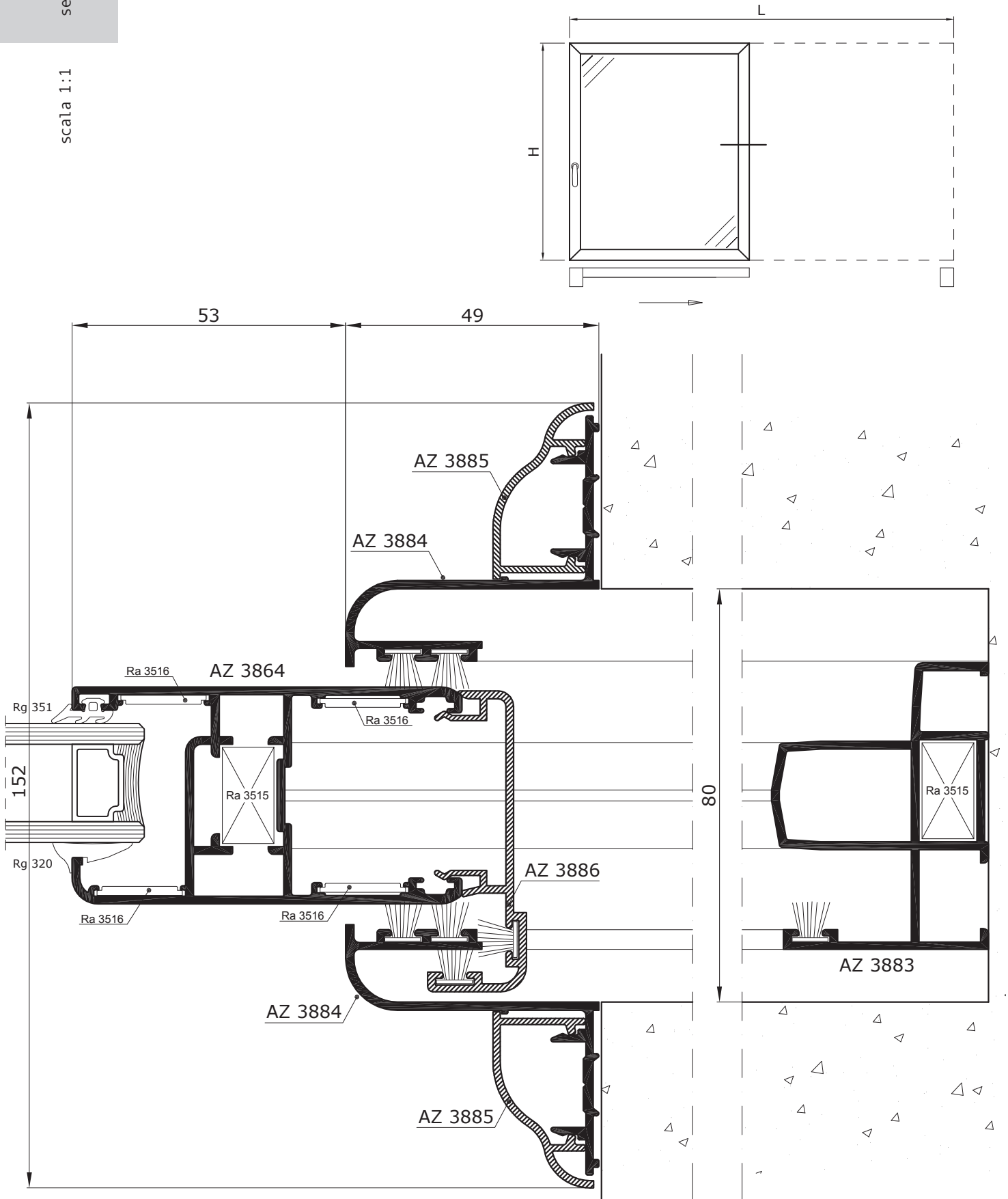

ANTE AD INCASSO
- persiana esterna -

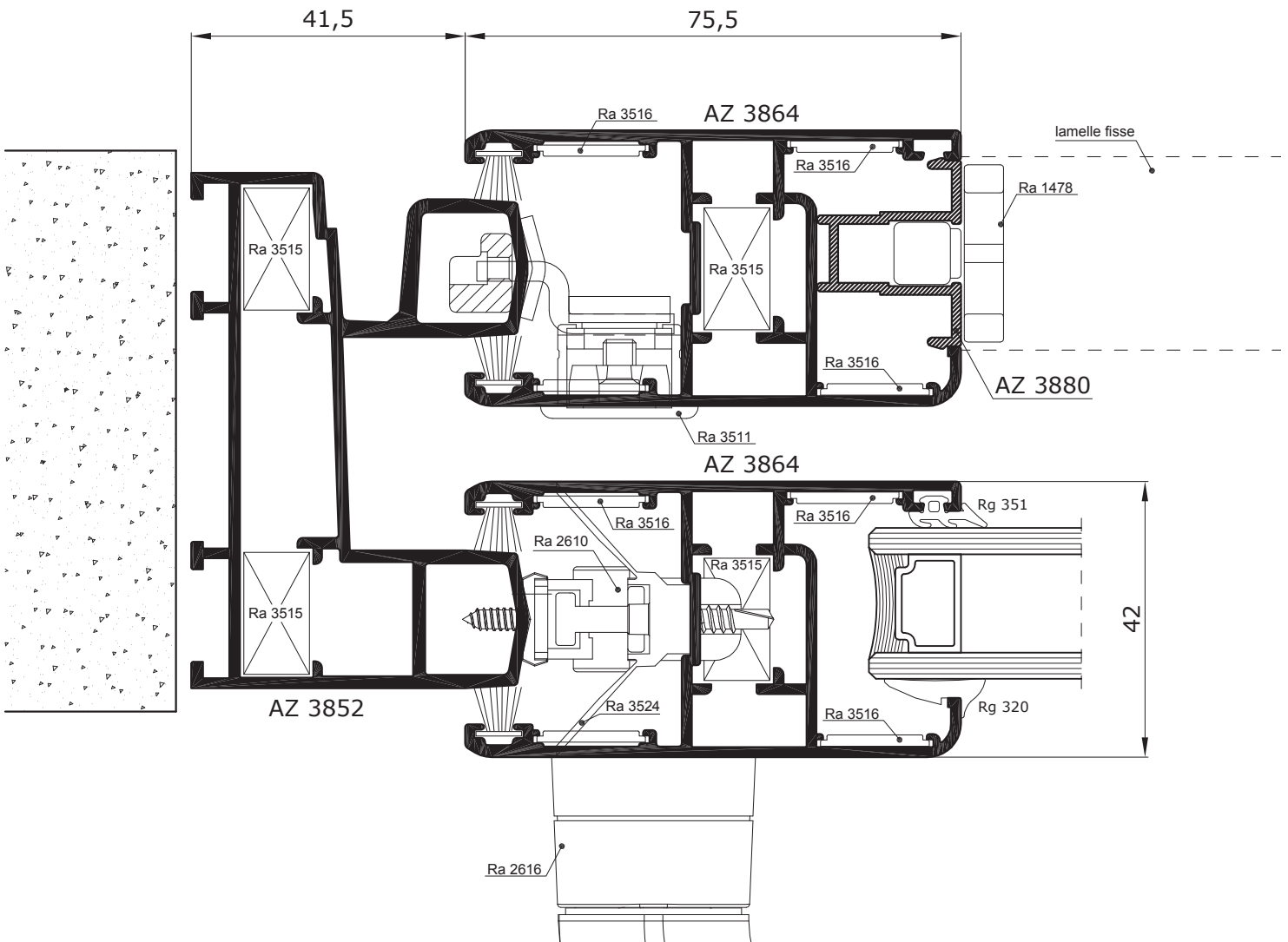
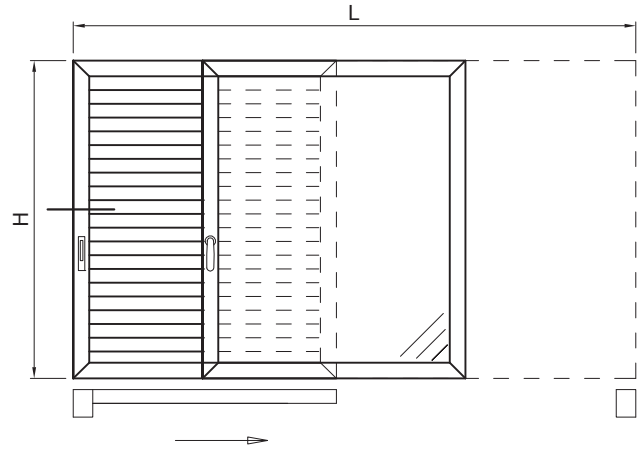

ANTE AD INCASSO
- persiana esterna -

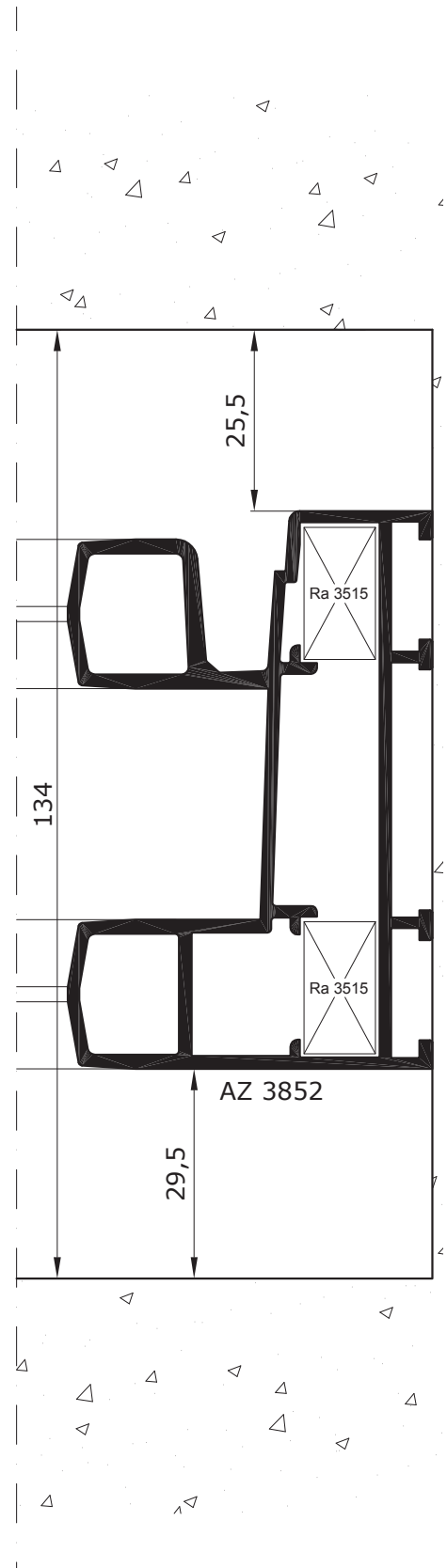
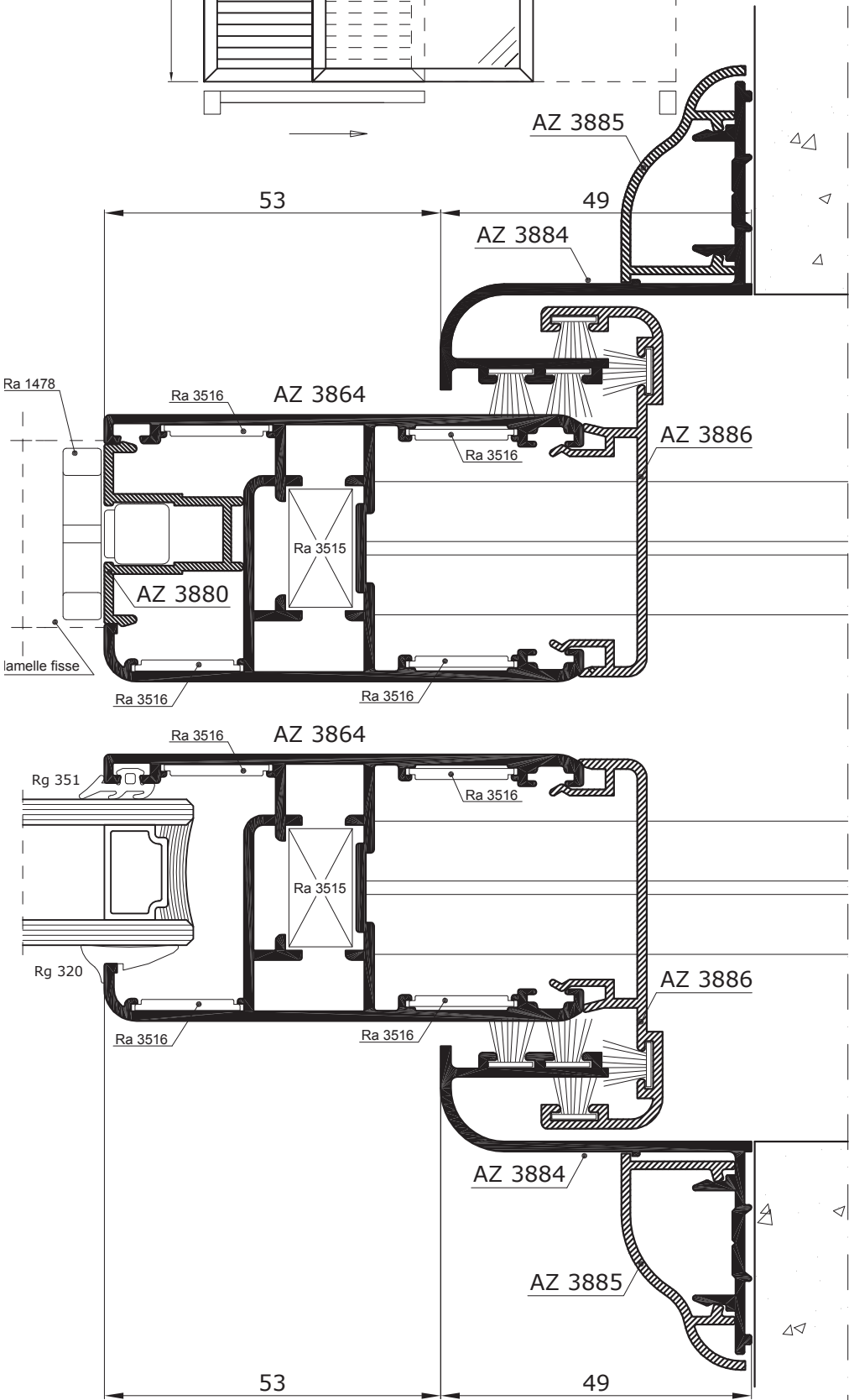
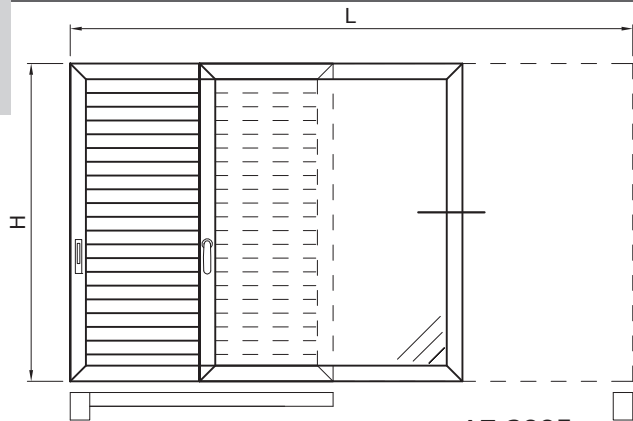

FINESTRA A 2 ANTE CON SOPRALUCE APRIBILE
- Atlantis 45 -

scala 1:1

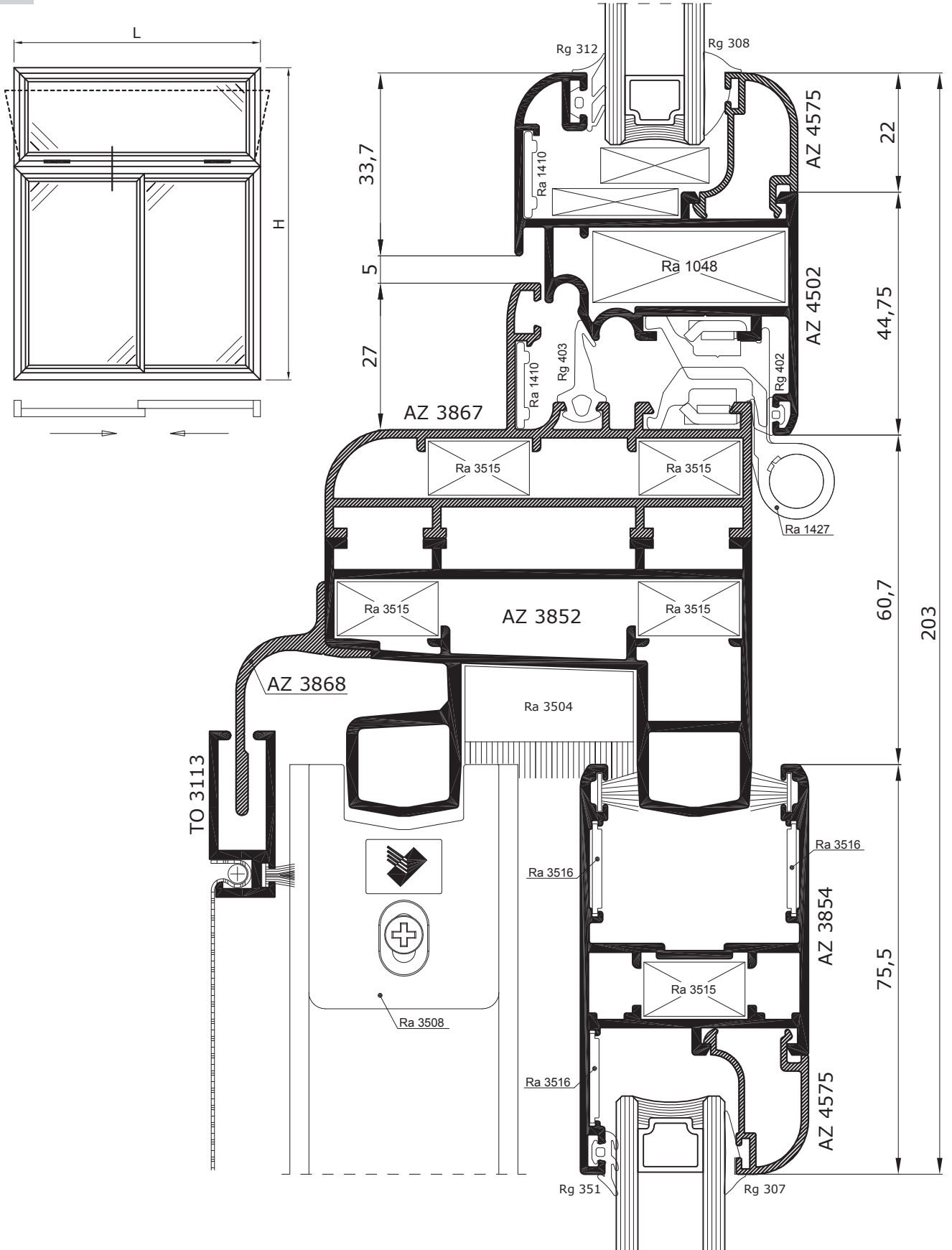

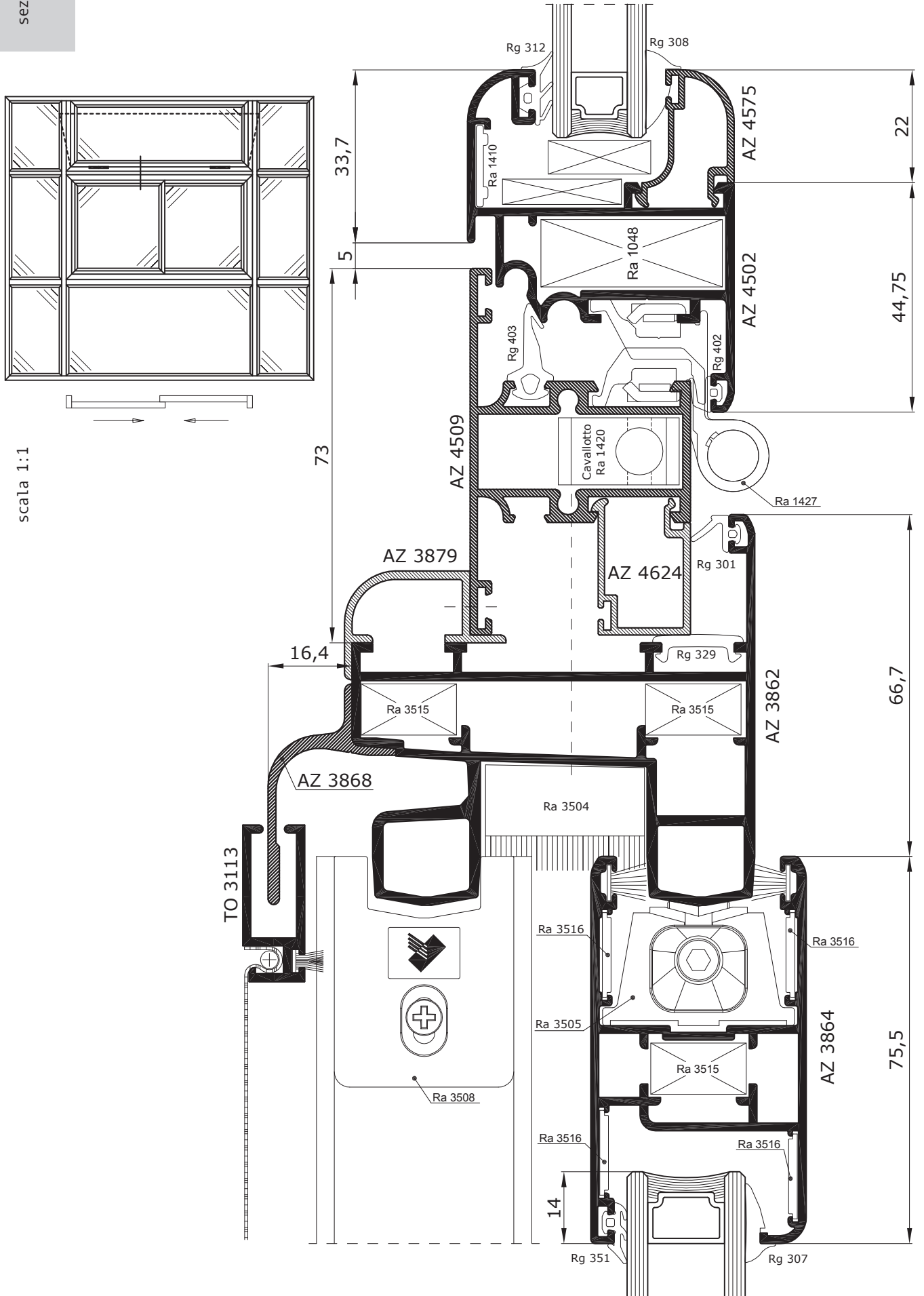

FINESTRA A 2 ANTE
- anta con fermavetro -



scala 1:1

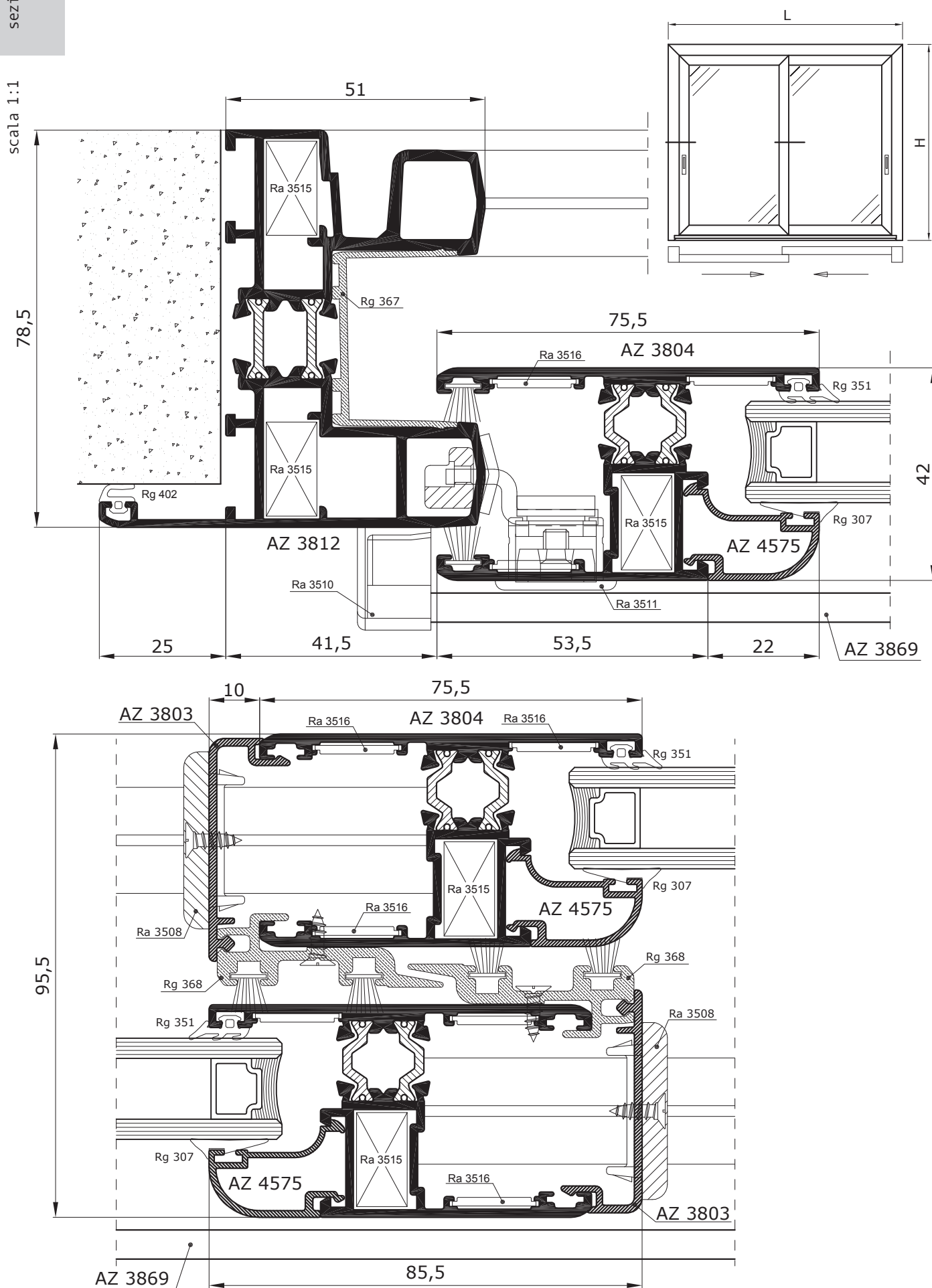

FINESTRA A 2 ANTE
- anta con fermavetro -

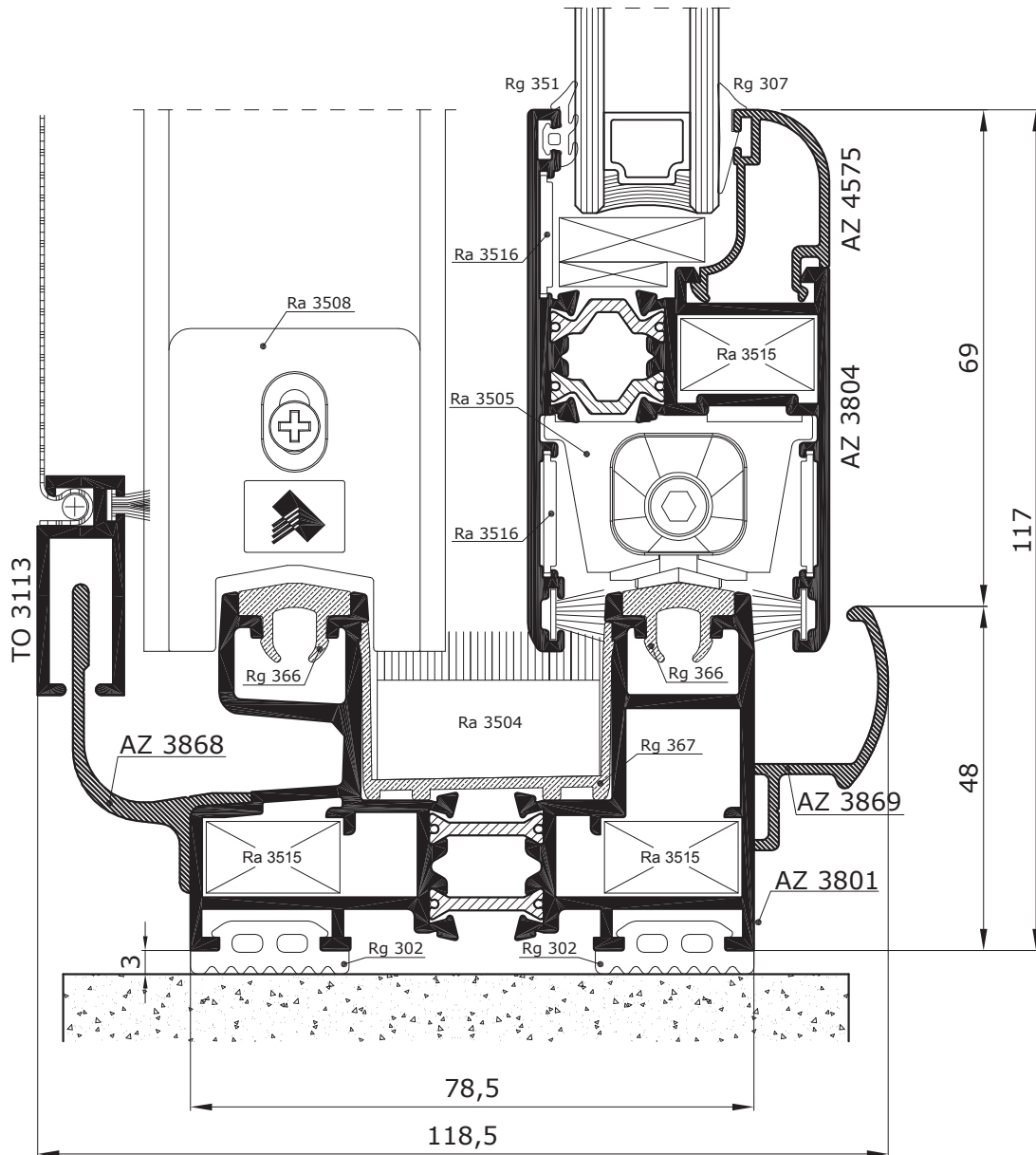
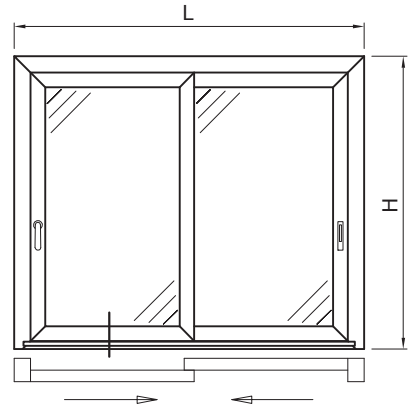

FINESTRA A 2 ANTE
- anta con fermavetro -

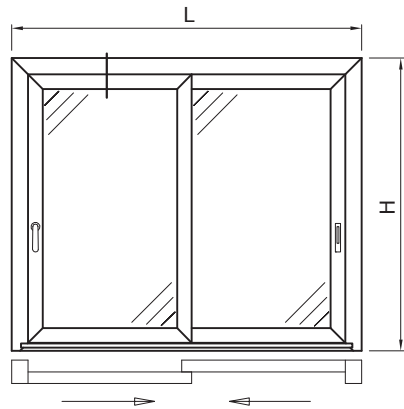
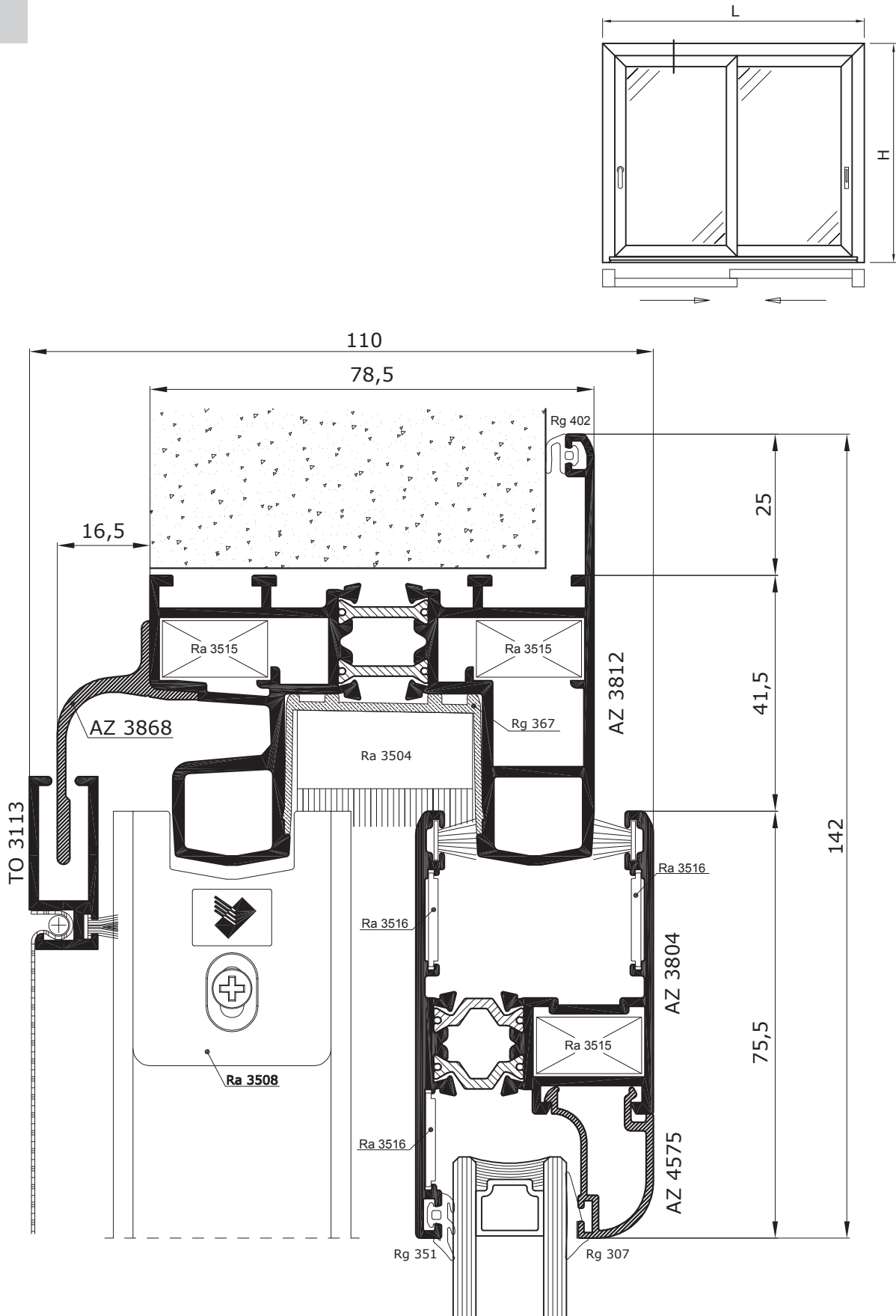



scala 1:1

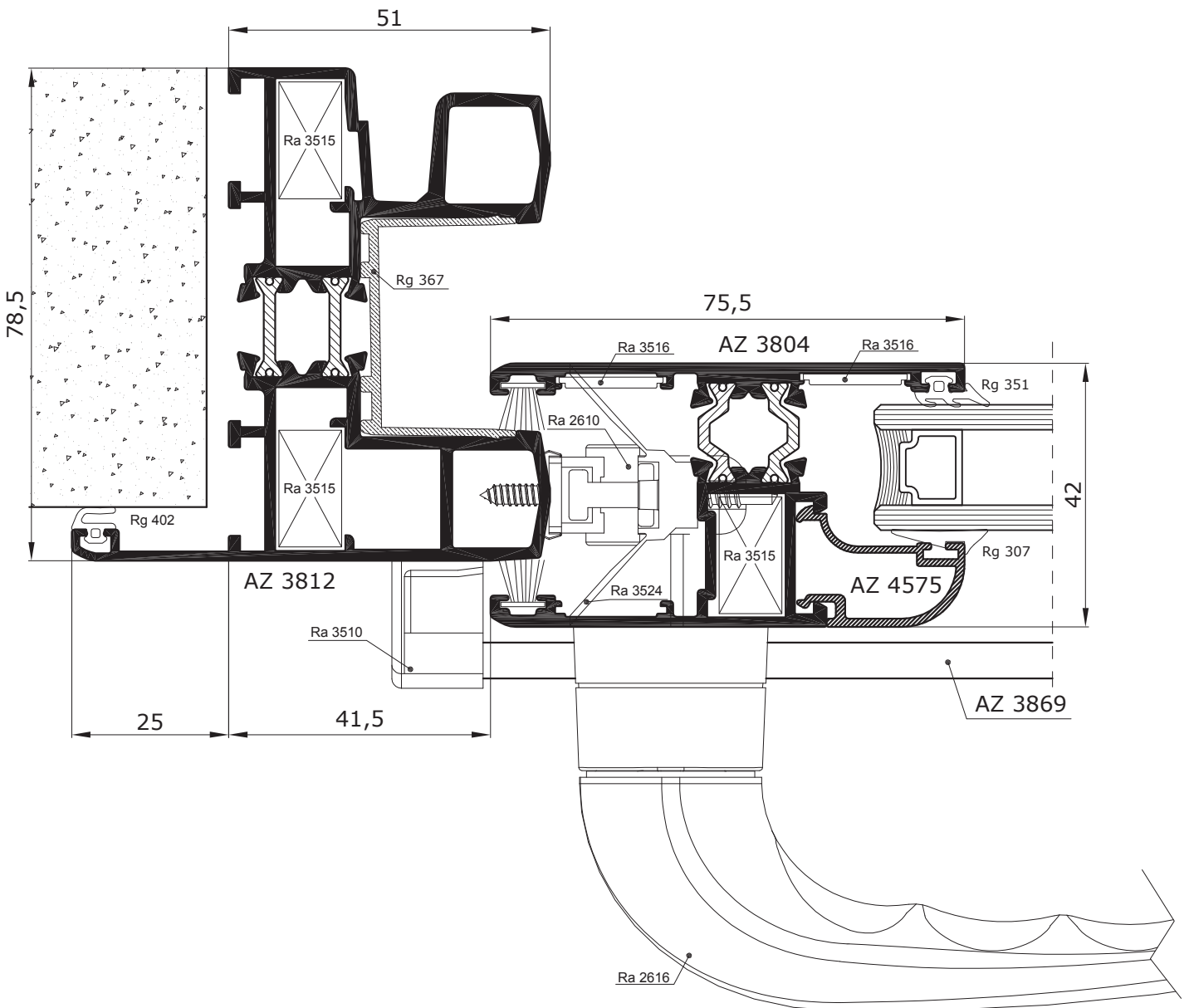
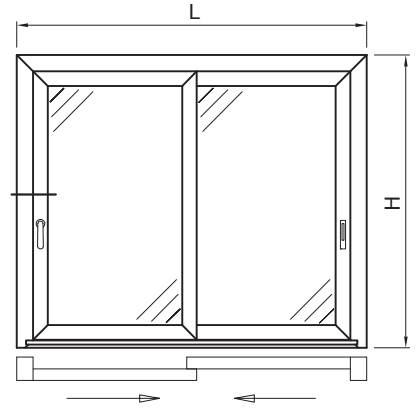

FINESTRA A 2 ANTE
- anta con fermavetro telaio ridotto -

scala 1:1

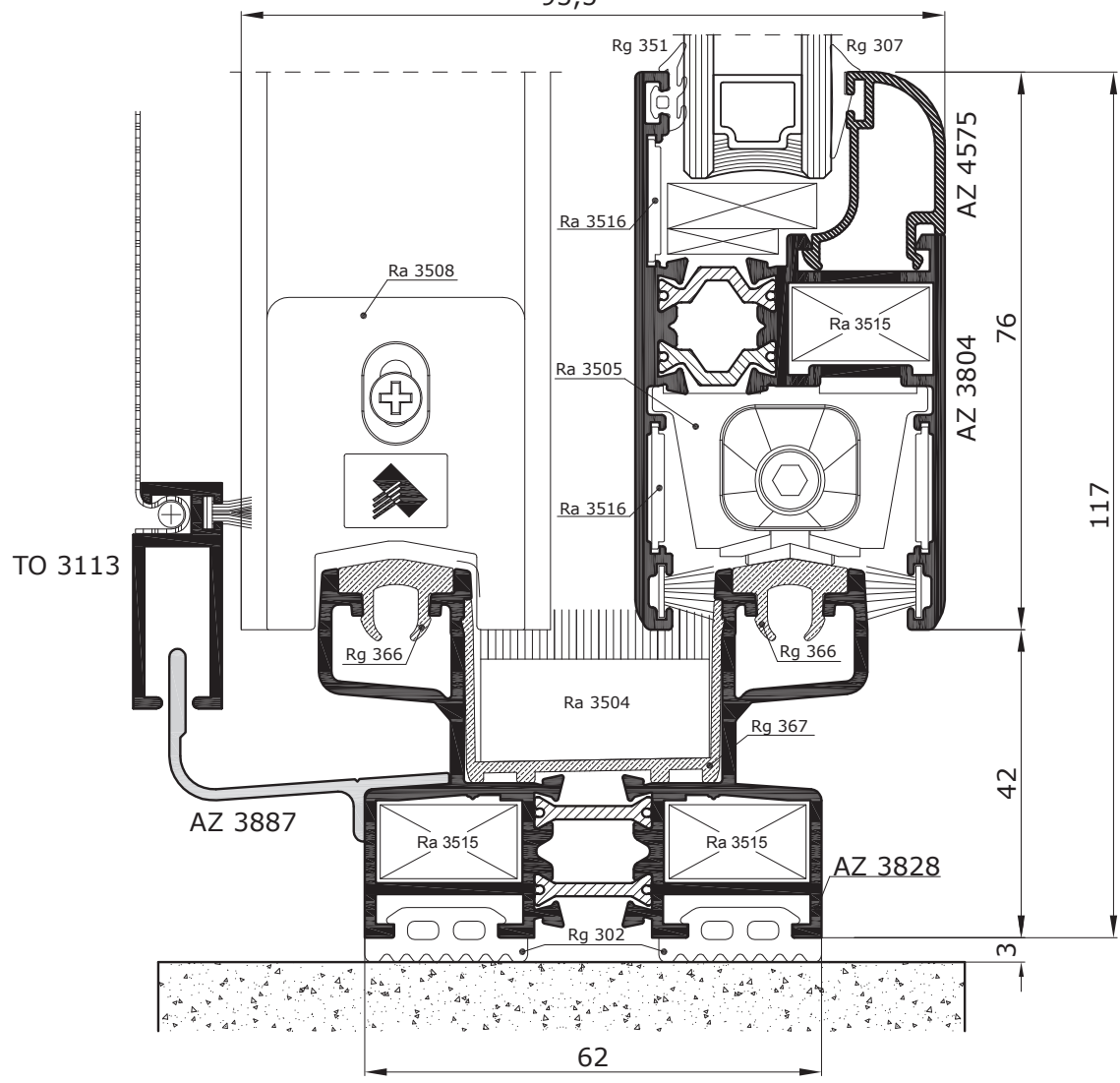
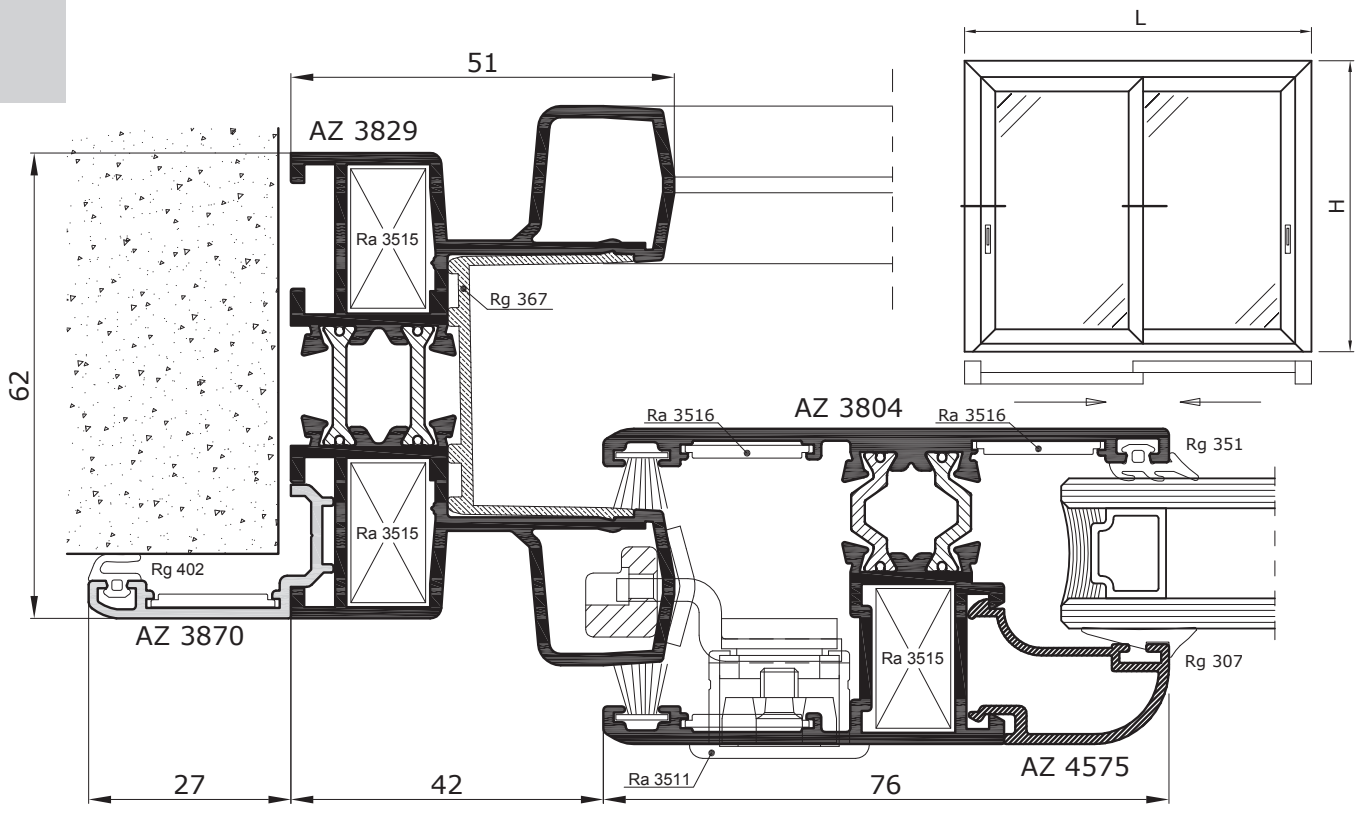

FINESTRA A 2 ANTE
- anta vetro ad infilare e telaio da 98 mm -

scala 1:1

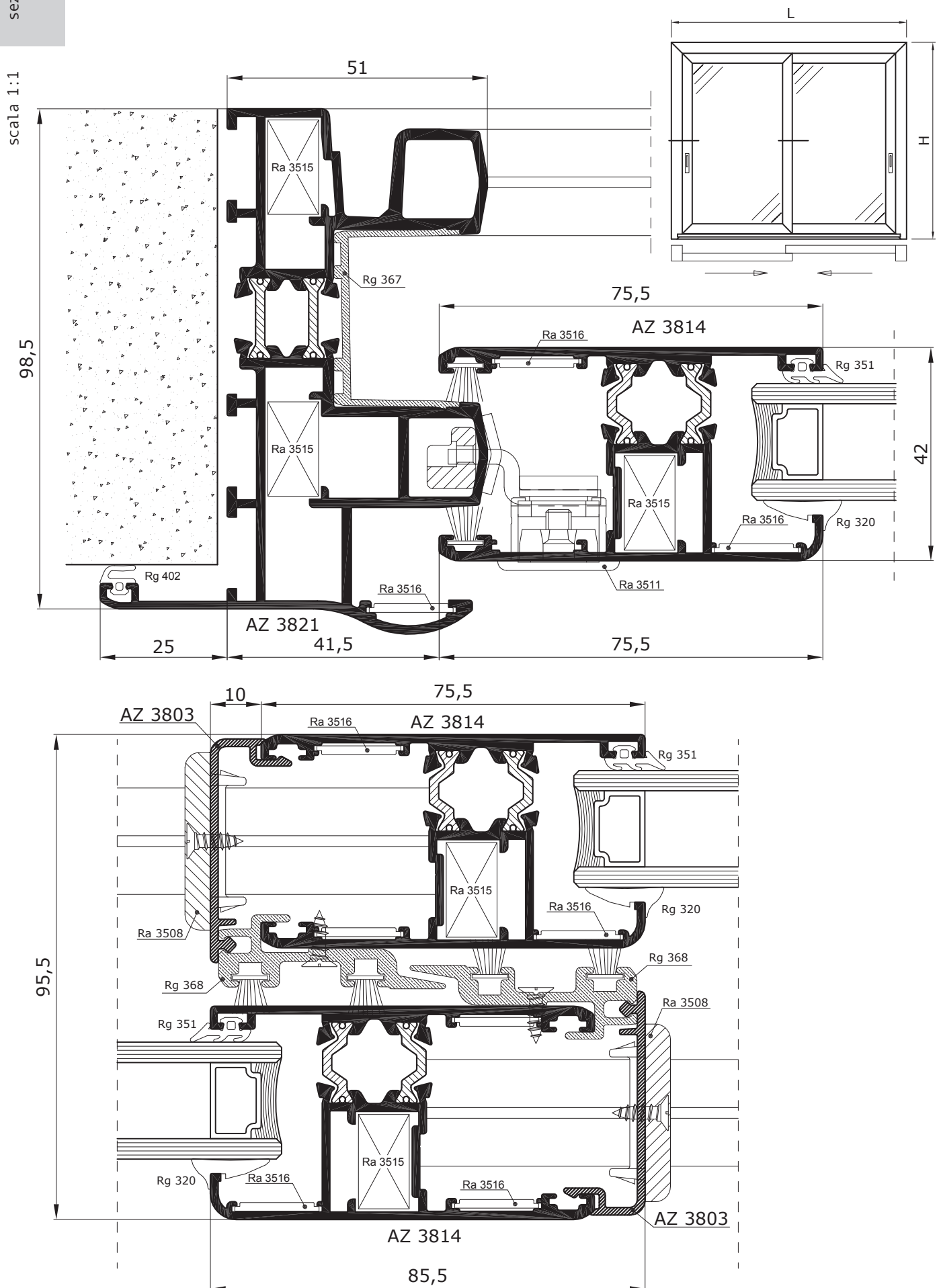

FINESTRA A 2 ANTE
- anta vetro ad infilare e telaio da 98 mm -

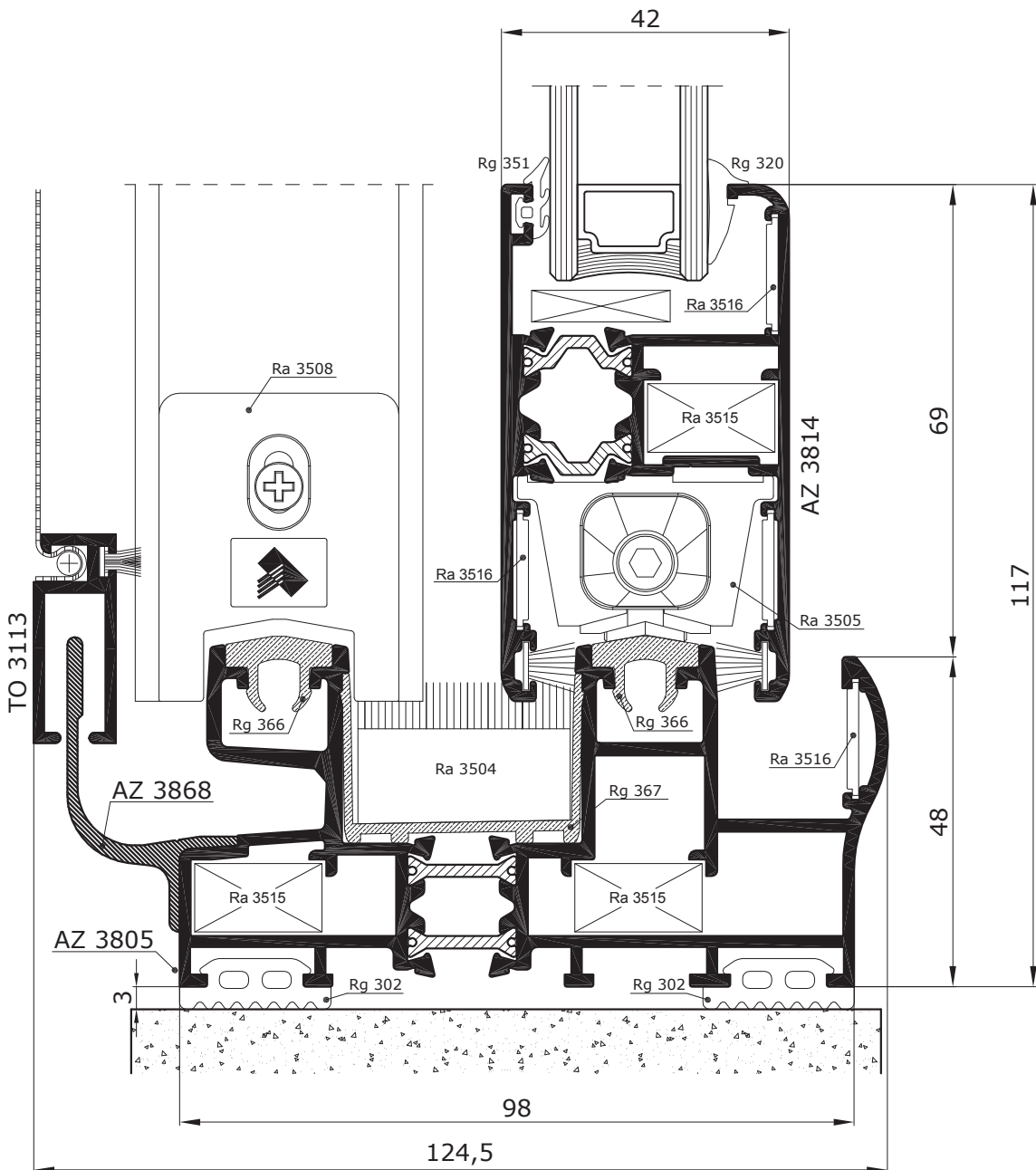
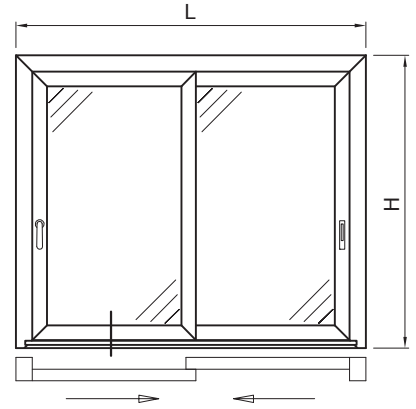



scala 1:1

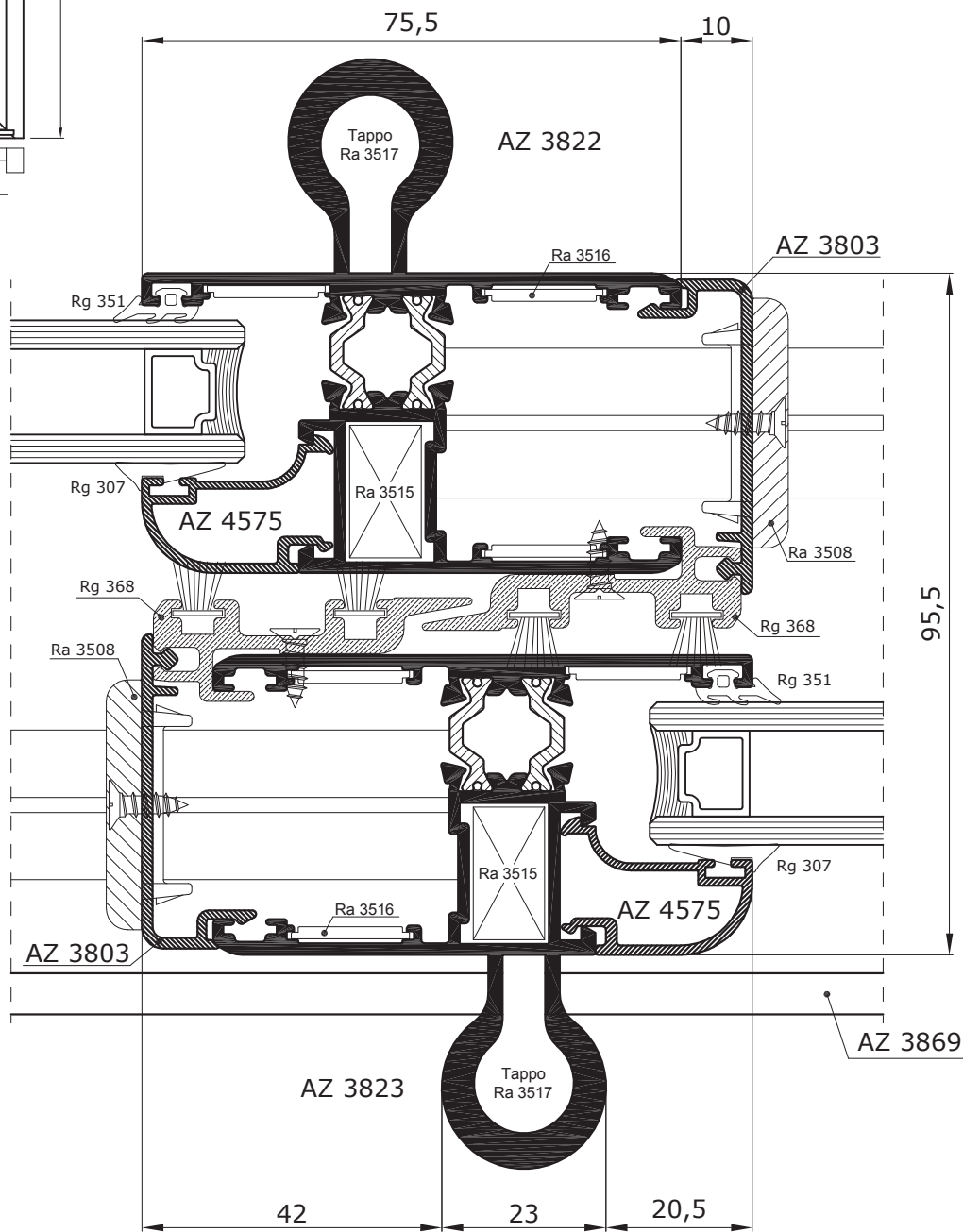
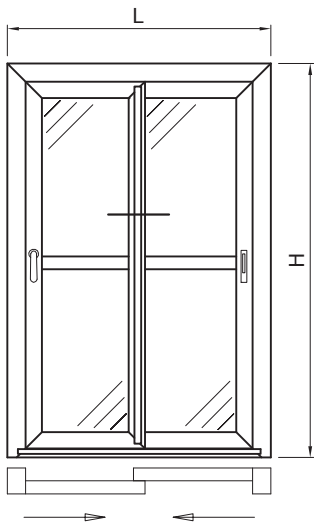



scala 1:1

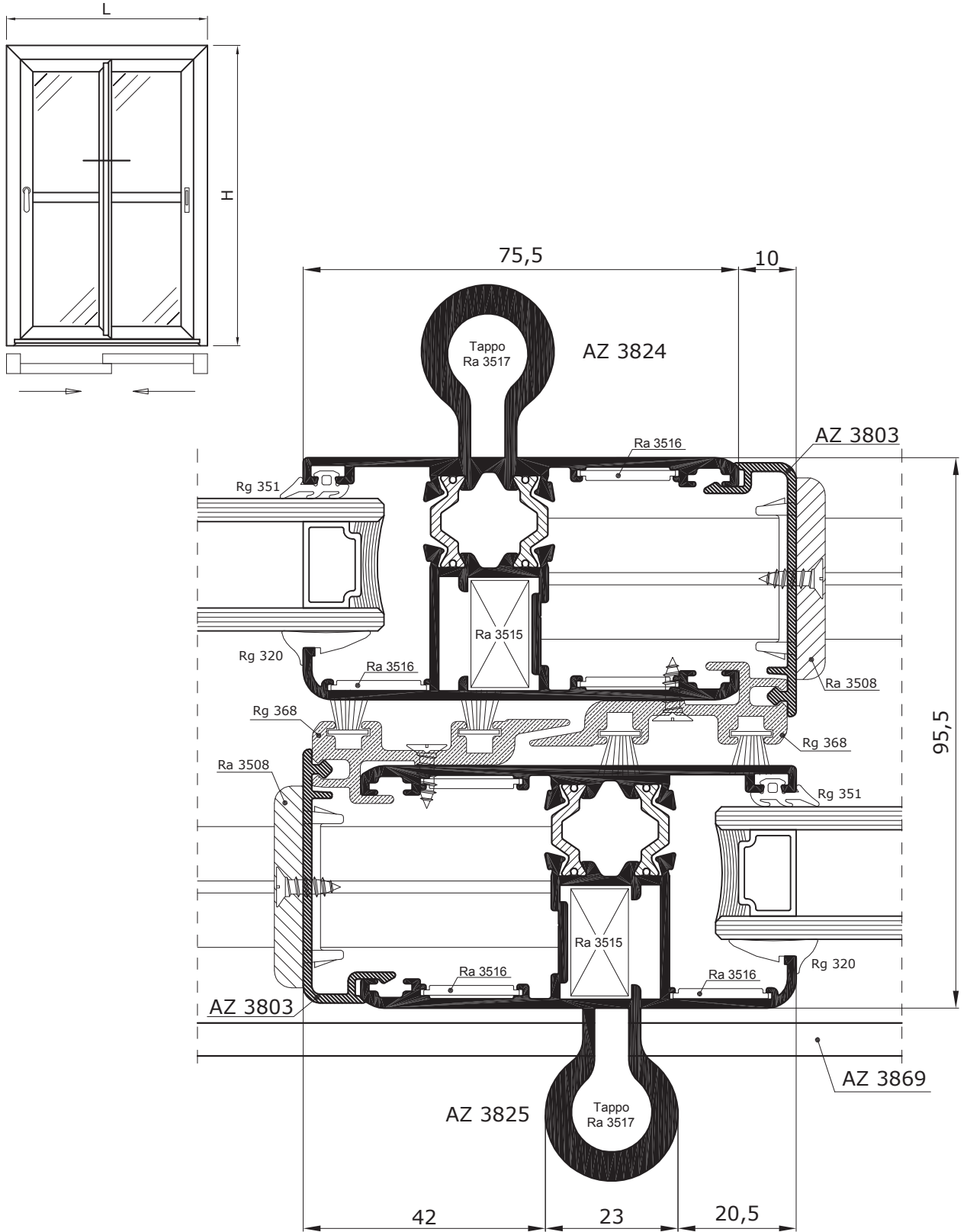



scala 1:1

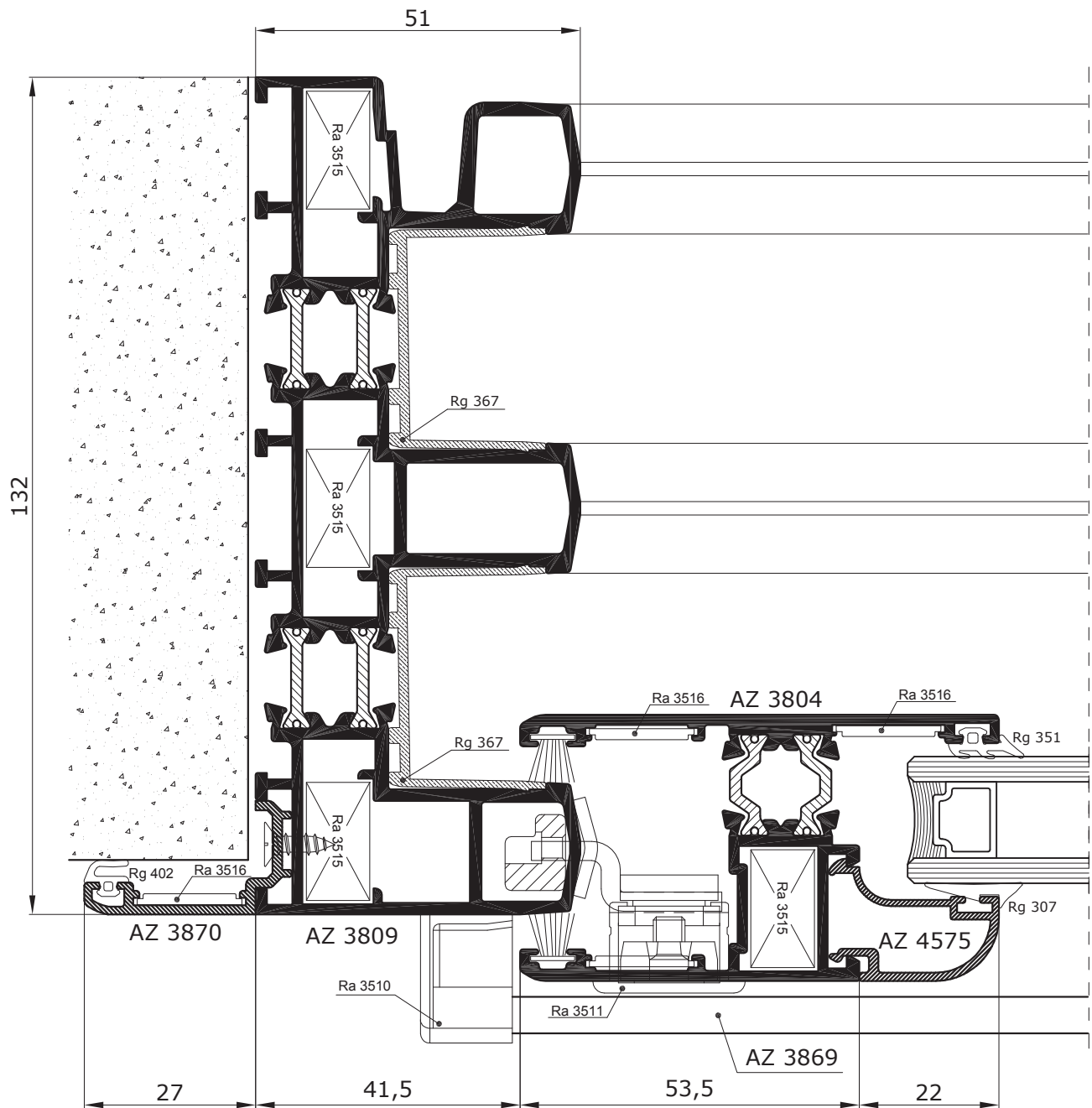
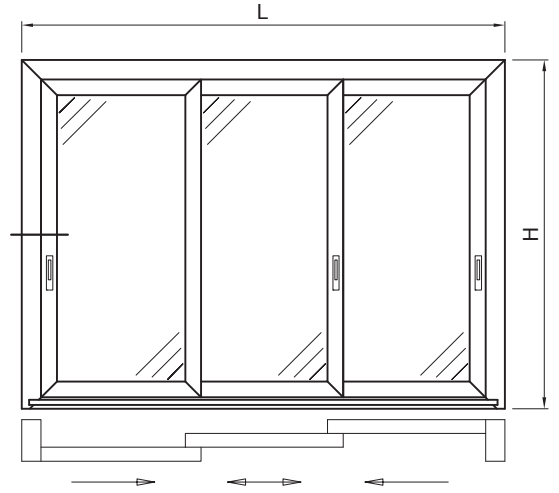

FINESTRA A 3 ANTE
- telaio a tre vie -

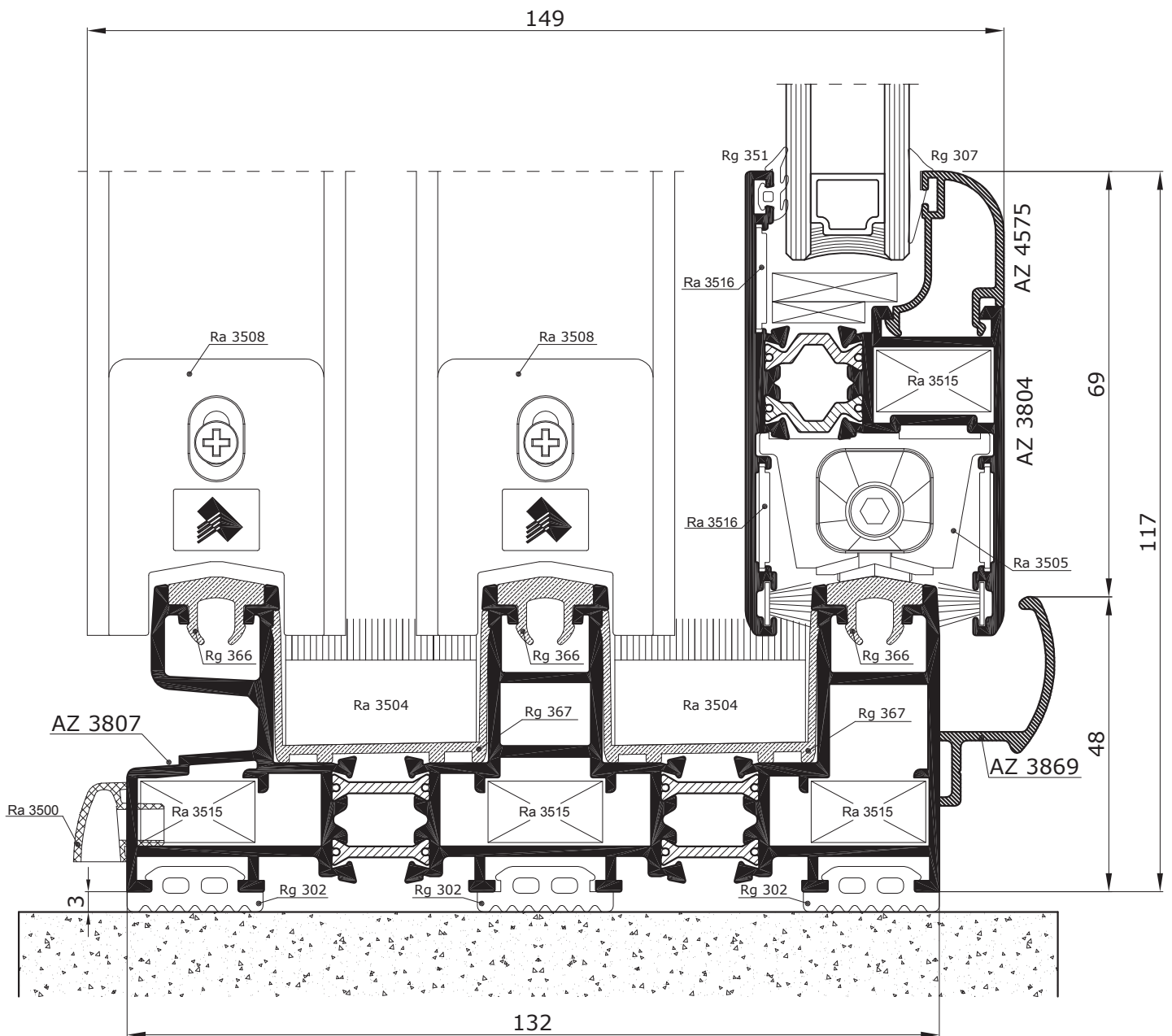
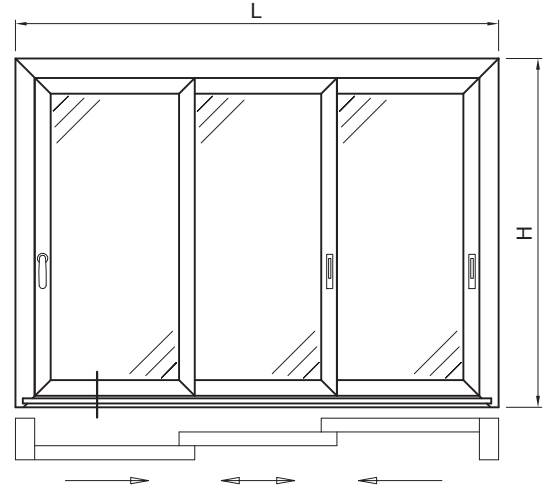



scala 1:1

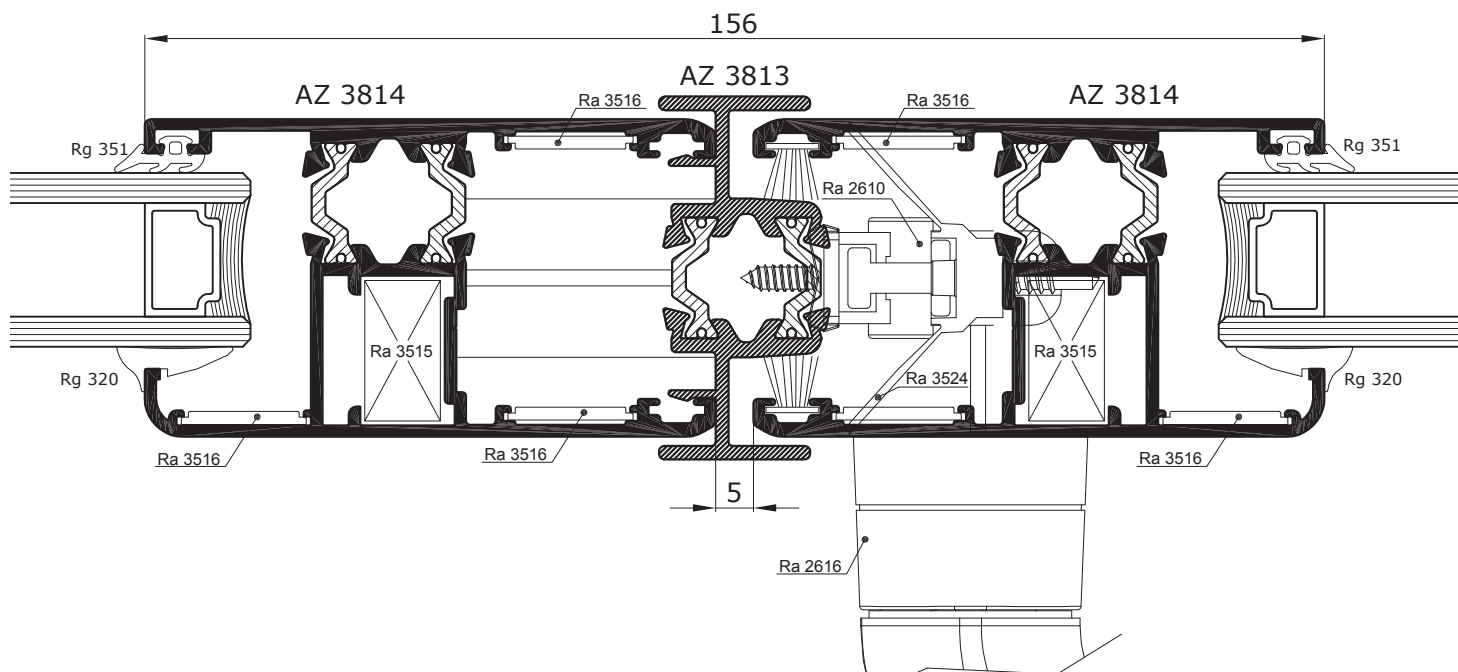
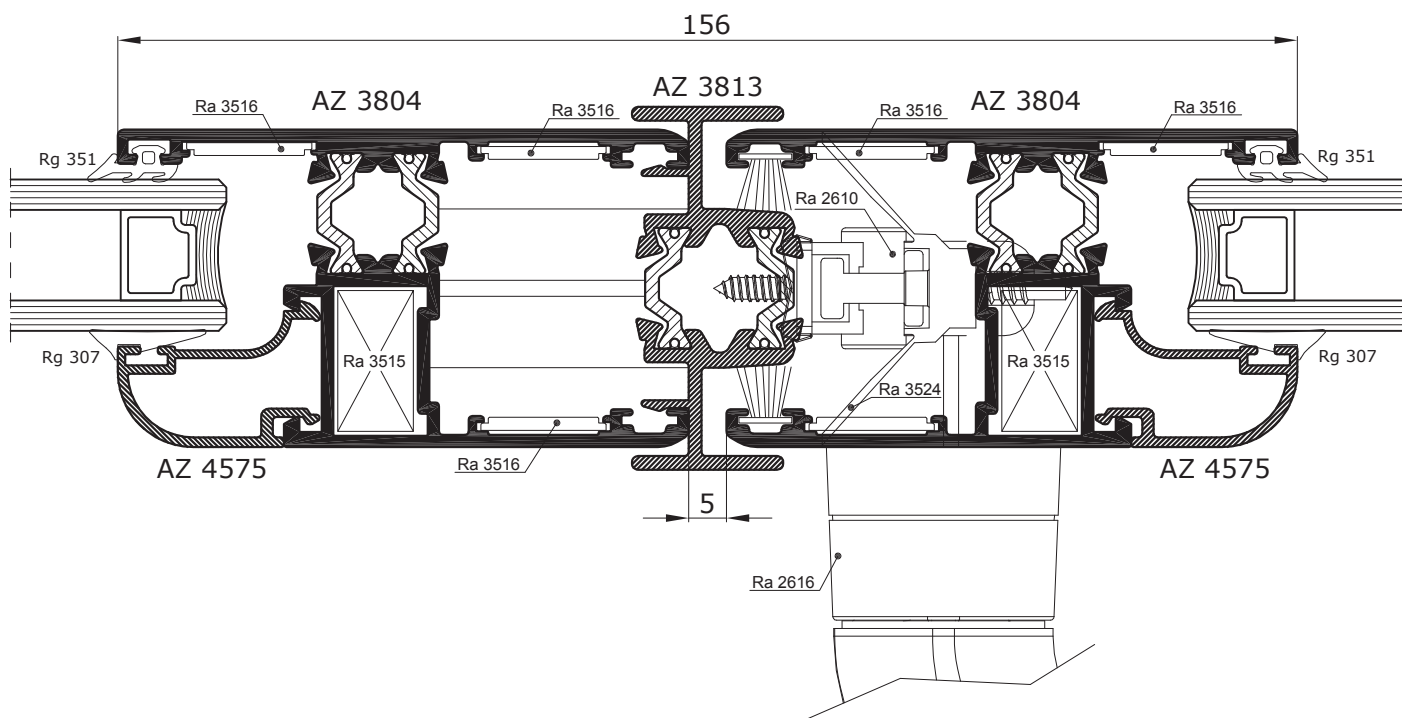
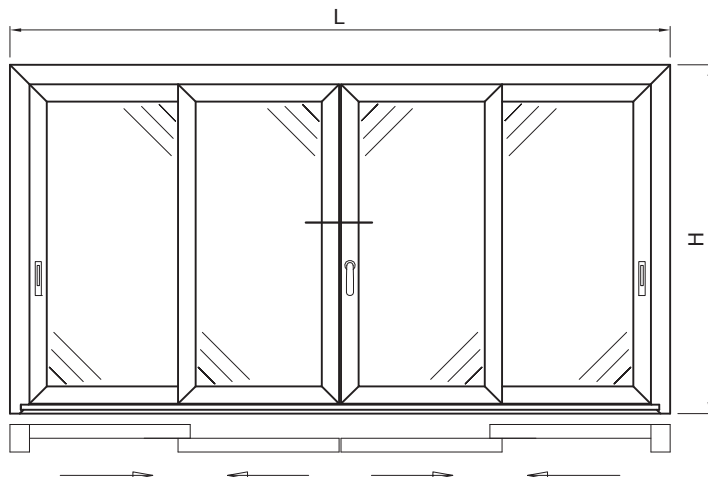

FINESTRA A 2 ANTE CON SOPRALUCE APRIBILE
- Atlantis 55TT -

scala 1:1

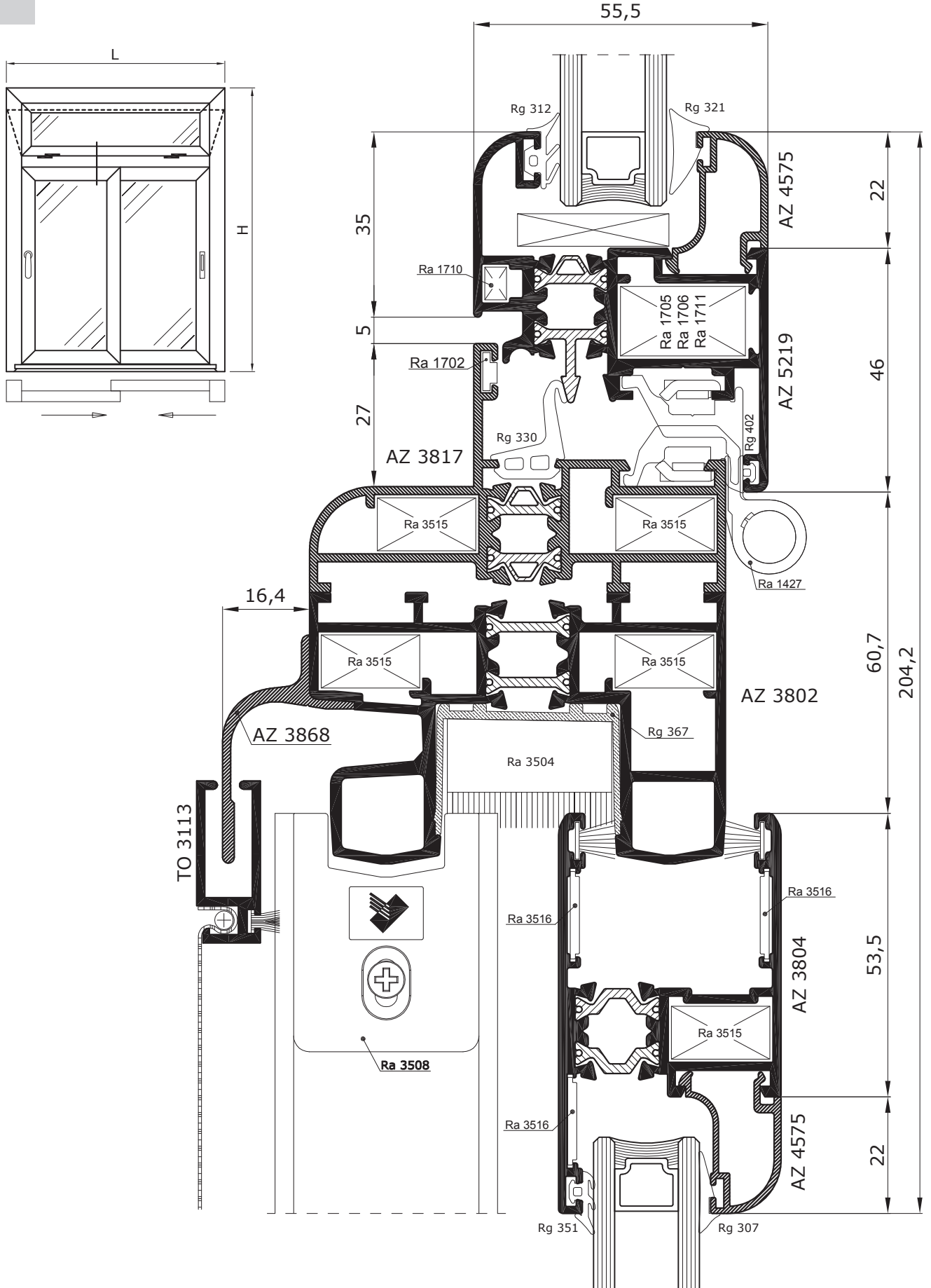

FINESTRA A 2 ANTE CON SOPRALUCE APRIBILE
- Atlantis 68TT -

scala 1:1

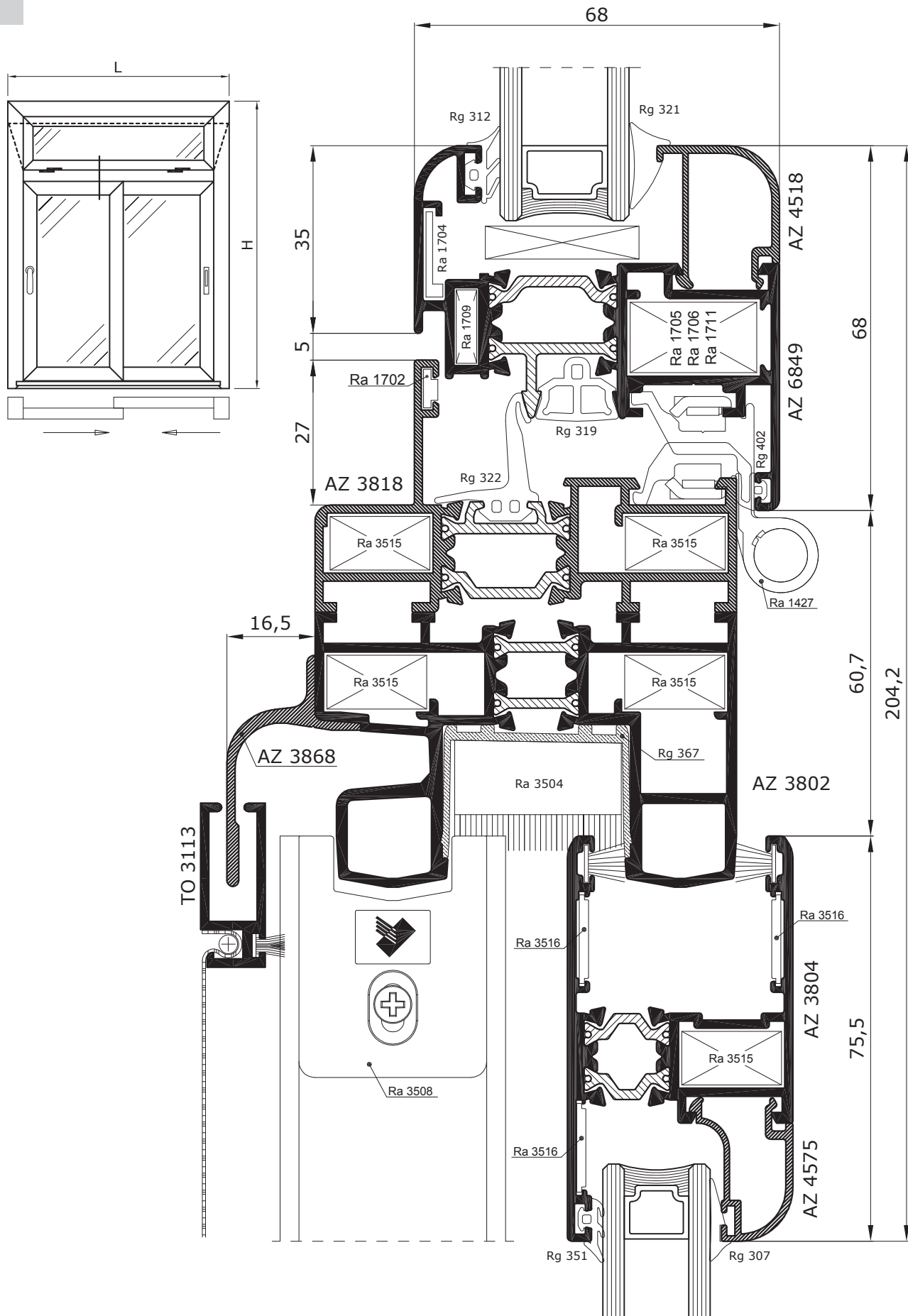



scala 1:1

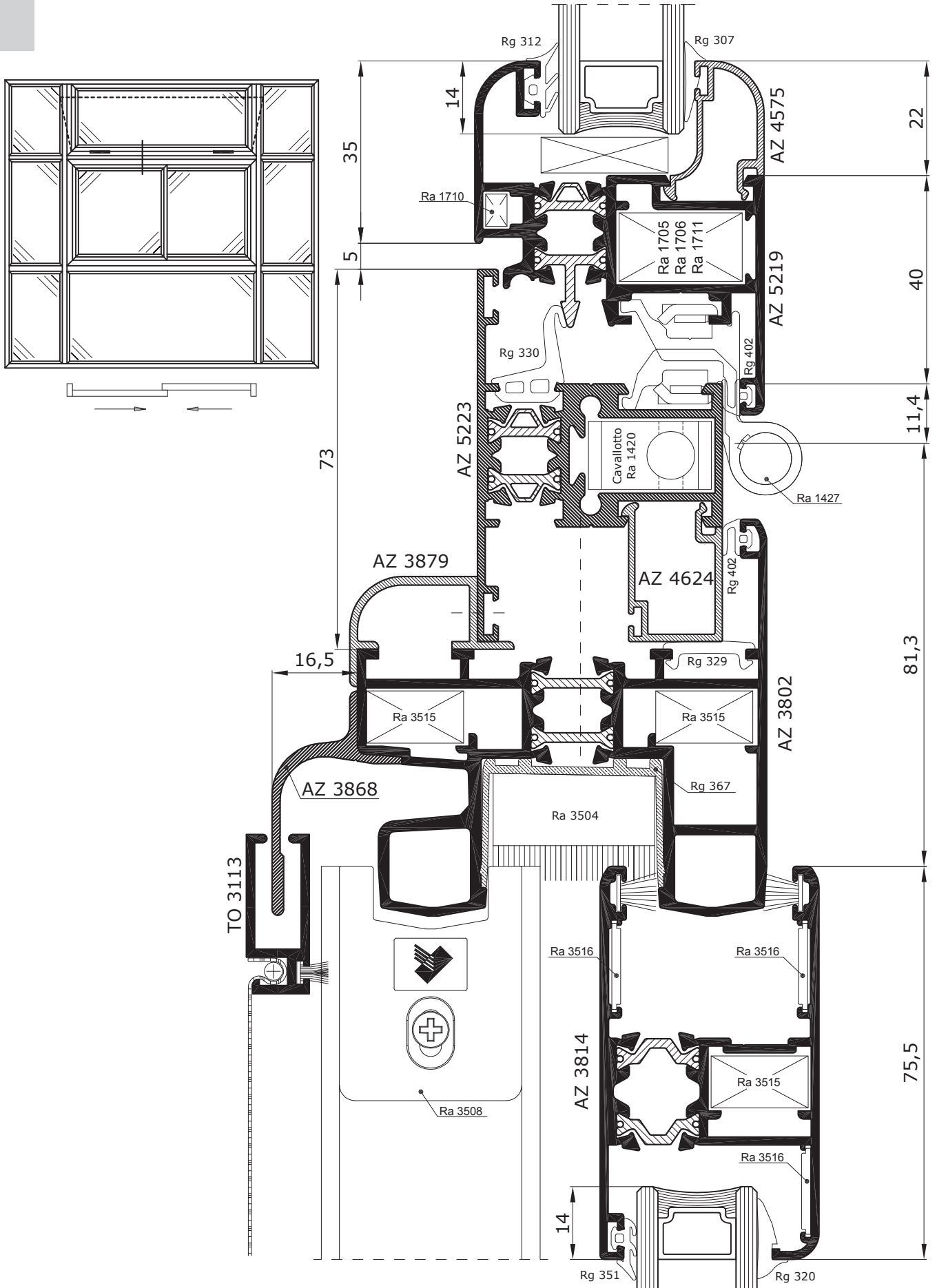

VETRATA CON FINESTRA A 2 ANTE
- Atlantis 68TT -

scala 1:1

